



Reach In Coolers and Freezers

Models RE-CN-0021-HC, 0035-HC, 0041-HC, 0067-HC,
FR-CN-0737-HC, 0035-HC, 1372-HC, 2057-HC
Items 50024, 50110, 50026, 50028, 50023, 50111, 50025, 50027

Instruction Manual



Toll Free: 1-800-465-0234
Fax: 905-607-0234
Email: service@omcan.com
www.omcan.com



Table of Contents

Model RE-CN-0021-HC / Model RE-CN-0035-HC / Model RE-CN-0041-HC
Model RE-CN-0067-HC / Model FR-CN-0737-HC
Model FR-CN-0035-HC / FR-CN-1372-HC / Model FR-CN-2057-HC

Section	Page
Disclaimer -----	3
General Information -----	4 - 5
Safety and Warranty -----	5 - 7
Technical Specifications -----	7 - 8
Installation -----	8 - 9
Maintenance -----	10
Troubleshooting -----	11 - 12
Controller Instructions -----	13 - 17
Parts Breakdown -----	18 - 33
Electrical Schematics -----	34 - 41
Notes -----	42
Warranty Registration -----	43

OMCAN IS NOT RESPONSIBLE FOR ANY DAMAGES DUE TO WATER LEAKS. WARRANTY FOR WATER LEAKS IS VOID IF THE AMBIENT ROOM TEMPERATURE EXCEEDS 75°F AND 55% RELATIVE HUMIDITY, AND THE APPLIANCE DRAIN IS NOT CONNECTED DIRECTLY TO A FLOOR DRAIN.

OMCAN N'EST PAS RESPONSABLE DES DOMMAGES DUS AUX FUITES D'EAU. LA GARANTIE POUR LES FUITES D'EAU EST ANNULÉE SI LA TEMPÉRATURE AMBIANTE DE LA PIÈCE DÉPASSE 75°F ET 55% D'HUMIDITÉ RELATIVE, ET SI LE DRAIN DE L'APPAREIL N'EST PAS RACCORDÉ DIRECTEMENT À UN DRAIN DE PLANCHER.

OMCAN NO SE HACE RESPONSABLE DE LOS DAÑOS CAUSADOS POR FUGAS DE AGUA. LA GARANTÍA POR FUGAS DE AGUA QUEDA ANULADA SI LA TEMPERATURA AMBIENTE SUPERA LOS 75°F Y EL 55% DE HUMEDAD RELATIVA, Y EL DESAGÜE DEL APARATO NO ESTÁ CONECTADO DIRECTAMENTE A UN DESAGÜE DE PISO.

General Information

Omcan Manufacturing and Distributing Company Inc., Food Machinery of America, Inc. dba Omcan and Omcan Inc. are not responsible for any harm or injury caused due to any person's improper or negligent use of this equipment. The product shall only be operated by someone over the age of 18, of sound mind, and not under the influence of any drugs or alcohol, who has been trained in the correct operation of this machine, and is wearing authorized, proper safety clothing. Any modification to the machine voids any warranty, and may cause harm to individuals using the machine or in the vicinity of the machine while in operation.

CHECK PACKAGE UPON ARRIVAL

Upon receipt of an Omcan shipment please inspect for external damage. If no damage is evident on the external packaging, open carton to ensure all ordered items are within the box, and there is no concealed damage to the machine. If the package has suffered rough handling, bumps or damage (visible or concealed), please note it on the bill of lading before accepting the delivery and contact Omcan within 24 hours, so we may initiate a claim with the carrier. A detailed report on the extent of the damage caused to the machine must be filled out within three days, from the delivery date shown in the shipping documents. Omcan has no recourse for damaged products that were shipped collect or third party.

Before operating any equipment, always read and familiarize yourself with all operation and safety instructions.

Omcan would like to thank you for purchasing this machine. It's of the utmost importance to save these instructions for future reference. Also save the original box and packaging for shipping the equipment if servicing or returning of the machine is required.

Omcan Fabrication et distribution Compagnie Limitée et Food Machinery d'Amérique, dba Omcan et Omcan Inc. ne sont pas responsables de tout dommage ou blessure causé du fait que toute personne ait utilisé cet équipement de façon irrégulière. Le produit ne doit être exploité que par quelqu'un de plus de 18 ans, sain d'esprit, et pas sous l'influence d'une drogue ou d'alcool, qui a été formé pour utiliser cette machine correctement, et est vêtu de vêtements de sécurité appropriés. Toute modification de la machine annule toute garantie, et peut causer un préjudice à des personnes utilisant la machine ou des personnes à proximité de la machine pendant son fonctionnement.

VÉRIFIEZ LE COLIS DÈS RÉCEPTION

Dès réception d'une expédition d'Omcan veuillez inspecter pour dommages externes. Si aucun dommage n'est visible sur l'emballage externe, ouvrez le carton afin de s'assurer que tous les éléments commandés sont dans la boîte, et il n'y a aucun dommage dissimulé à la machine. Si le colis n'a subi aucune mauvaises manipulations, de bosses ou de dommages (visible ou cachée), notez-le sur le bond de livraison avant d'accepter la livraison et contactez Omcan dans les 24 heures qui suivent, pour que nous puissions engager une réclamation auprès du transporteur. Un rapport détaillé sur l'étendue des dommages causés à la machine doit être rempli dans un délai de trois jours, à compter de la date de livraison indiquée dans les documents d'expédition. Omcan n'a aucun droit de recours pour les produits endommagés qui ont été expédiés ou cueillis par un tiers transporteur.

Avant d'utiliser n'importe quel équipement, toujours lire et vous familiariser avec toutes les opérations et les



General Information

consignes de sécurité.

Omcan voudrais vous remercier d'avoir choisi cette machine. Il est primordial de conserver ces instructions pour une référence ultérieure. Également conservez la boîte originale et l'emballage pour l'expédition de l'équipement si l'entretien ou le retour de la machine est nécessaire.

Omcan Empresa De Fabricacion Y Distribucion Inc. Y Maquinaria De Alimentos De America, Inc. dba Omcan y Omcan Inc. no son responsables de ningun daño o perjuicio causado por cualquier persona inadecuada o el uso descuidado de este equipo. El producto solo podra ser operado por una persona mayor de 18 años, en su sano juicio y no bajo alguna influencia de droga o alcohol, y que este ha sido entrenado en el correcto funcionamiento de esta máquina, y ésta usando ropa apropiada y autorizada. Cualquier modificación a la máquina anula la garantía y puede causar daños a las personas usando la máquina mientras esta en el funcionamiento.

REVISE EL PAQUETE A SU LLEGADA

Tras la recepcion de un envio Omcan favor inspeccionar daños externos. Si no hay daños evidentes en el empaque exterior, Habra el carton para asegurarse que todos los articulos solicitados estén dentro de la caja y no encuentre daños ocultos en la máquina. Si el paquete ha sufrido un manejo de poco cuidado, golpes o daños (visible o oculto) por favor anote en la factura antes de aceptar la entrega y contacte Omcan dentro de las 24 horas, de modo que podamos iniciar una reclamación con la compañía. Un informe detallado sobre los daños causados a la máquina debe ser llenado en el plazo de tres días, desde la fecha de entrega que se muestra en los documentos de envío. Omcan no tiene ningun recurso por productos dañados que se enviaron a recoger por terceros.

Antes de utilizar cualquier equipo, siempre lea y familiarizarse con todas las instrucciones de funcionamiento y seguridad.

Omcan le gustaría darle las gracias por la compra de esta máquina. Es de la mayor importancia para salvar estas instrucciones para futuras consultas. Además, guarda la caja original y el embalaje para el envío del equipo si servicio técnico o devolución de la máquina que se requiere.

Safety and Warranty

Please pay close attention to the safety notices in this section. Disregarding these notices may lead to serious injury and/or damage to the unit.

ATTENTION

- To minimize shock and fire hazards, be sure not to overload outlet. Please designate one outlet for your unit.
- Do not use extension cords.

Safety and Warranty

- Do not put your hands under the unit when the units is required to be moved.
- When the unit is not in use for a long period of time, please unplug the unit from the outlet.
- After unplugging the unit, wait at least 10 minutes before re-plugging it. Failure to do so could cause damage to the compressor.

UNPLUG CORD

- To minimize shock and fire hazards, please do not plug or unplug the cord with wet hands.
- During maintenance and cleaning, please unplug the unit.

PROPER GROUNDING REQUIRED

- To minimize shock and fire hazards, make sure that the unit is properly grounded.

PROHIBITION

- Do not attempt to remove or repair any component unless instructed by factory.
- Make sure that the unit is not resting on or against the electrical cord and plug.
- To minimize personal injury, do not hang on the doors.
- Do not store any flammable and explosive gas or liquids inside the unit.
- Do not attempt to alter or tamper with the electrical cord.

RESIDENTIAL USERS: vendor assumes no liability for parts or labor coverage for component failure or other damages resulting from installation in non-commercial or residential applications. The right is reserved to deny shipment for residential usage; if this occurs, you will be notified as soon as possible.

2 YEARS PARTS AND LABOUR / 5 YEARS PARTS ONLY ON COMPRESSOR WARRANTY

Within the warranty period, contact Omcan Inc. at 1-800-465-0234 to schedule an Omcan authorized service technician to repair the equipment locally.

Unauthorized maintenance will void the warranty. Warranty covers electrical and part failures, not improper use.

Please see <https://omcan.com/disclaimer> for complete info.

WARNING:

The packaging components are classified as normal solid urban waste and can therefore be disposed of without difficulty.

In any case, for suitable recycling, we suggest disposing of the products separately (differentiated waste) according to the current norms.



Safety and Warranty

DO NOT DISCARD ANY PACKAGING MATERIALS IN THE ENVIRONMENT!

Technical Specifications

REACH IN COOLERS

Model	RE-CN-0021-HC	RE-CN-0035-HC	RE-CN-0041-HC	RE-CN-0067-HC
Item Number	50024	50110	50026	50028
Net Volume	650 L / 22.95 cu.ft.	749.3 L / 26.46 cu.ft.	1321 L / 46.65 cu.ft.	2040 L / 72.04 cu.ft.
Temperature Range	0.6 - 5°C / 33 - 41°F			
Max Ambient Temp Rating	24°C / 75°F			
Horsepower	0.2 HP	0.5 HP	0.25+ HP	0.75 HP
Electrical	110-120V / 60Hz / 1			
Current	2.6A	4.1A	3.8A	9A
Refrigerant	R290			
Isolation Material	Cyclopentane			
Cooling System	Ventilated			
Number of Doors	1	2	2	3
Number of Shelves	3	6	6	9
Shelf Capacity	59.5 lbs. / 27 kgs.	88 lbs. / 39.9 kgs.	59.5 lbs. / 27 kgs.	
Dimensions	29" x 32.2" x 82.5" 736 x 818 x 2095mm	39.5" x 29.5" x 82.5" 1004 x 750 x 2095mm	54" x 32.2" x 82.5" 1371 x 818 x 2095mm	80.9" x 32.2" x 82.5" 2054 x 818 x 2095mm
Interior Dimensions	27.1" x 24.4" x 53.5" 688 x 620 x 1360mm	35" x 24.4" x 51.6" 888 x 620 x 1310mm	49.4" x 27.1" x 60.2" 1255 x 688 x 1530mm	76.3" x 27.1" x 60.2" 1938 x 688 x 1530mm
Packaging Dimensions	31" x 34" x 85" 787 x 864 x 2159mm	42.2" x 31.9" x 82.5" 1070 x 810 x 2095mm	56.7" x 35" x 83.5" 1440 x 890 x 2120mm	83.5" x 35" x 83.5" 2120 x 890 x 2120mm
Weight	282.2 lbs. / 128 kgs.	308 lbs. / 139.7 kgs.	447.5 lbs. / 203 kgs.	617.3 lbs. / 280 kgs.
Packaging Weight	337.3 lbs. / 153 kgs.	374 lbs. / 169.6 kgs.	513.7 lbs. / 233 kgs.	705.5 lbs. / 320 kgs.

Technical Specifications

REACH IN FREEZERS

Model	FR-CN-0737-HC	FR-CN-0035-HC	FR-CN-1372-HC	FR-CN-2057-HC
Item Number	50023	50111	50025	50027
Net Volume	650 L / 22.95 cu.ft.	749.3 L / 26.46 cu.ft.	1331 L / 46.65 cu.ft.	2040 L / 72.04 cu.ft.
Temperature Range	-22.2 to -17.8°C / -8 to 0°F			
Max Ambient Temp Rating	24°C / 75°F			
Horsepower	0.5 HP	0.83 HP	1 HP	1.25 HP
Electrical	110-120V / 60Hz / 1			
Current	7.1A	6.7A	10.7A	12A
Refrigerant	R290			
Isolation Material	Cyclopentane			
Cooling System	Ventilated			
Number of Doors	1	2		3
Number of Shelves	3	6		9
Shelf Capacity	59.5 lbs. / 27 kgs.	88 lbs. / 39.9 kgs.	90.4 lbs. / 41 kgs.	61.7 lbs. / 28 kgs.
Dimensions	29" x 32.2" x 82.5" 736 x 818 x 2095mm	39.5" x 29.5" x 82.5" 1004 x 750 x 2095mm	54" x 32" x 82.5" 1372 x 813 x 2095mm	80.9" x 32.2" x 82.5" 2054 x 818 x 2095mm
Interior Dimensions	24.4" x 27.1" x 53.5" 620 x 688 x 1360mm	35" x 24.4" x 51.6" 888 x 620 x 1310mm	49.4" x 27" x 60.2" 1255 x 686 x 1530mm	76.3" x 27.1" x 60.2" 1938 x 688 x 1530mm
Packaging Dimensions	31" x 34" x 85" 787 x 864 x 2159mm	42.1" x 31.9" x 82.5" 1070 x 810 x 2095mm	56.3" x 34.6" x 85.4" 1430 x 879 x 2169mm	83.5" x 35" x 83.5" 2120 x 890 x 2120mm
Weight	282.2 lbs. / 128 kgs.	308 lbs. / 139.7 kgs.	496 lbs. / 225 kgs.	674.6 lbs. / 306 kgs.
Packaging Weight	357.1 lbs. / 162 kgs.	374 lbs. / 169.6 kgs.	560 lbs. / 254 kgs.	765 lbs. / 347 kgs.

Installation

IMPORTANT!!!PLEASE READ BEFORE INSTALLATION

- If the unit has recently been transported. Please let unit stand still for a minimum of 24 hours before plugging it in.
- Make sure that the unit drops down to desired temperature before loading the unit with product.
- Make sure that there is proper ventilation around the unit in the area where it will operate.
- Make sure all accessories are installed(i.e. shelves, shelf clips, casters) before plugging the unit in.

- Please read through the operation / owners manual in its entirety.

CABINET LOCATION GUIDELINES

- Install the unit on strong and leveled surfaces.
 - unit may make unpleasant noises if surface is uneven.
 - unit may malfunction if surface is uneven.
- Install the unit in an indoor, well-ventilated area.
 - unit performs more efficiently in a well-ventilated area.
 - for best performance, please maintain clearance of 6" on the back of the unit.
 - outdoor use may cause decreased efficiency and damage to the unit.
- Avoid installation in a high humidity and/or dusty area.
 - humidity could cause unit to rust and decrease efficiency of the unit.
 - dust collected on condenser coil will cause unit to malfunction. Clean the condenser at least once a month with a brush or clean cloth.
- Select a location away from heat and moisture-generating equipment.
 - high ambient temperature will cause the compressor to overwork, leading to higher energy bills and gradual breakdown of the unit.

ELECTRICAL

Please ensure that the required voltage of the compressor is being supplied at all times. Low or high voltage can detrimentally affect the refrigeration unit. All units should be plugged into a grounded and properly-sized electrical outlet with appropriate overcurrent protection. Please refer to the electrical requirement on the nameplate. Please make sure that your unit has its own dedicated outlet. Do not use an extension cord.

REVERSING THE DOORS (OPTIONAL)

Note: this only applies to the single door units.

Only perform these steps with another person present to ensure the door does not fall over.

1. Open the door.
2. Remove the screws from the top panel, then open the top panel.
3. Remove the screws of the bottom louver, then remove the louver.
4. Unscrew all of the screws from the upper hinge.
5. Unscrew all of the screws from the lower hinge and remove the door and hinges.
6. Place the former upper hinge at the bottom of the unit, parallel to where the lower hinge is, do the same with the former lower hinge except for the top. Screw the hinges into place.
7. Reassemble the door so it is facing the opposite direction.
8. Reassemble the top panel and the lower louver.
9. The door is now reversed.

Maintenance

CLEANING THE CONDENSER COIL

- For efficient operation, it is important that the condenser surface be kept free of dust, dirt, and lint.
- We recommend cleaning the condenser coil and fins at least once per month.
- Clean with a commercial condenser coil cleaner, available from any kitchen equipment retailer. Brush the condenser fins from top to bottom, not side to side.
- After cleaning, straighten any bent condenser fins with a fin comb.

CLEANING THE FAN BLADE AND MOTOR

- If necessary, clean the fan blades and motor with a soft cloth, If it is necessary to wash the fan blades, cover the fan motor to prevent moisture damage.

CLEANING THE INTERIOR OF UNIT

- When cleaning the cabinet interior, use a solvent of warm water and mild soap.
- Do not use steel wool, caustic soap, abrasive cleaners, or bleach that may damage the stainless steel surface.
- Wash door gaskets on a regular basis, preferably weekly. Simply remove door gasket from the frame of the door, soak in warm water and soap for thirty (30) minutes, dry with soft cloth, and replace.
- Check door gaskets for proper seal after they are replaced.
- Periodically remove the shelves and pilasters from the unit and clean them with mild soap and warm water. To remove the pilasters, first remove the shelves and shelf brackets. Then, simply lift the pilaster up and out.

WARNING

Disconnect power cord before cleaning any parts of the unit.

ICE ACCUMULATION MAY OCCUR IN FREEZERS

- **Try to reduce the amount of time the freezer doors remain open to prevent ice accumulation.**
- **Keep door seals clean to prevent air leakage.**
- **Scrape off any ice accumulated or try manual defrost mode.**

Troubleshooting

Before requesting any service on your unit, please check the following points. Please note that this guide serve only as a reference for solutions to common problems.

SYMPTOM	POSSIBLE CAUSE	CORRECTIVE ACTION
Compressor not running.	Fuse blown or circuit breaker tripped.	Replace fuse or reset circuit breaker.
	Power cord unplugged.	Plug in power cord.
	Thermostat set too high.	Set thermostat to lower temperature.
	Cabinet in defrost cycle.	Wait for defrost cycle to finish.
Cabinet is noisy.	Loose part(s).	Locate and tighten loose part(s).
	Tubing vibration.	Ensure tubing is free from contact with other tubing or components.
Condensing unit runs for long periods of time.	Excessive amount of warm product placed in cabinet.	Allow adequate time for product to cool down.
	Prolonged door opening or door ajar.	Ensure doors are closed when not in use. Avoid opening doors for long periods of time.
	Door gasket(s) not sealing properly.	Ensure gaskets are snapped in completely. Remove gasket and wash with soap and water. Check condition of gasket and replace if necessary.
	Dirty condenser coil.	Clean the condenser coil.
	Evaporator coil iced over.	Unplug unit and allow coil to defrost. Make sure thermostat is not set too cold. Ensure that door gasket(s) are sealing properly.

Troubleshooting

Cabinet temperature is too warm.	Thermostat set too warm.	Set thermostat to lower temperature.
	Blocking air flow.	Re-arrange product to allow for proper air flow. Make sure there is at least four inches of clearance from evaporator.
	Excessive amount of warm product placed in cabinet.	Allow adequate time for product to cool down.
	Fuse blown or circuit breaker tripped.	Replace fuse or reset circuit breaker.
	Dirty condenser coil.	Clean the condenser coil.
	Prolonged door opening or door ajar.	Ensure doors are closed when not in use. Avoid opening doors for long periods of time.
	Evaporator coil iced over.	Unplug unit and allow coil to defrost. Make sure thermostat is not set too cold. Ensure that door gasket(s) are sealing properly.

Controller Instructions

Digital controller model: PJEZ for cooler



Dimensioni (mm) / Dimensions (mm)

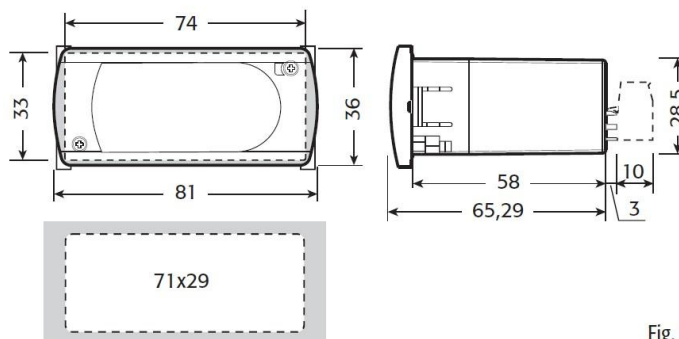







Fig. 1

Display and functions



During normal operation, the controller displays the value of the probe set using parameter/4(=1 ambient probe, default, = 2 second probe, = 3 third probe). In addition, the display has LEDs that indicate the activation of the control functions (see table 1), while the 3 buttons can be used to activate/deactivate some of the functions (see table 2).

LED's and Associated Functions (Table 1)

Icon	Function	Normal Operation			Start Up
		ON	OFF	Blink	
	Compressor	On	Off	Request	ON
	Fan	On	Off	Request	ON
	Defrost	On	Off	Request	ON
AUX	Aux	Output On	Output Off	-	ON
	Alarm	All	No Alarm	-	ON
	Clock	RTC fitted and enabled, at least 1 time band set	RTC not fitted or disabled, not even 1 time band set	-	ON if RTC fitted

Controller Instructions

Table of Functions activated by the buttons - Models S, X, Y, C (Table 2)

Button		Normal Operation		Start Up	
		Pressing the Button Alone	Pressed Together		
	Up ON/OFF	More than 3 sec: toggle ON/OFF	Start/Stop continuous cycle	-	
	Down Defrost	More than 3 sec: start/stop defrost			
	Set Mute	- 1 sec.: display/set the set point. - more than 3 secs.: access parameter setting menu (enter password) - mute audible alarm (buzzer)	-	Pressed together Start parameter reset procedure	For 1 sec. display firmware vers. code
					For 1 sec. RESET current EZY set

Setting the set point (desired temperature)

- Press **SET** for 1 sec, the set value will start flashing after a few moments.
- Increase or decrease the value using **UP** or **DOWN**.
- Press **SET** to confirm the new value.

Switching the device ON/OFF

Press **UP** for more than 3 sec. The control and defrost algorithms are now disabled and the Instrument displays the message "OFF" alternating with the temperature read by the set probe.

Manual defrost

Press for **DOWN** more than 3 sec (the defrost starts only the temperature conditions are valid).

Continuous cycle

Press **UP** and **DOWN** together for more than 3 sec.

Access and setting type F (frequent) and type C (configuration) parameters

1. Press **SET** for 3 sec (the display will show "PS").
2. • To access the type F and C parameter menu, enter the password "22" using **UP/DOWN**, press **SET** to confirm.
 - To access the F parameter menu only, press **SET** (without entering the password).

Controller Instructions

3. Scroll inside the parameter menu using **UP/DOWN**.

- To display/set the values of the parameter displayed, press **SET**, then **UP/DOWN** and finally **SET** to confirm the changes (returning to the parameter menu).

To save all the new values and exit the parameter menu, press **SET** for 3 s.

To exit the menu without saving the changed values (exit by timeout) do not press any button for at least 60 s.

Digital controller model: IR33 for freezer



Montaggio a pannello ir33/ir33 panel mounting:

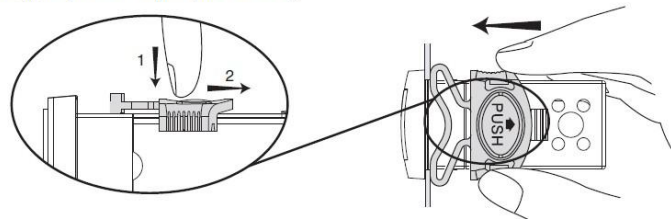



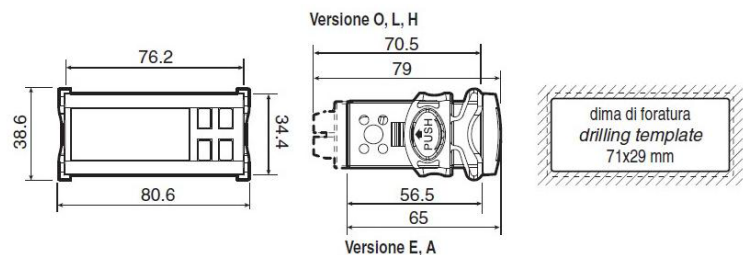

Montaggio a pannello mediante due staffe plastiche a scorrimento laterale
Panel mounting by two lateral sliding plastic brackets

Dimensioni (mm) /Dimensions (mm)







Signals on the display

The blinking status indicates a request for activation that cannot be implemented until the end of the corresponding delay times.



Icon	Function	ON	OFF	Blink	Startup
	Compressor	Compressor on	Compressor off	Request	
	Fan	Fan on	Fan off	Request	
	Defrost	Defrost in progress	Defrost not required	Request	
AUX	Aux	Auxiliary Output AUX active	Auxiliary Output AUX not active	Anti-sweat heater function active	
	Alarm	Delayed external alarm (before the expiry of the time 'A7')	No alarm present	Alarms in normal operation (eg. high/low temp.) or alarm from ext. digital input immediate or delayed	

Controller Instructions



	Clock	At least one timed defrost has been set	No timed defrost is present	Clock alarm	On if Real-Time Clock present
	Light	Auxiliary output light active	Auxiliary output light not active	Anti-sweat heater function active	
	Service		No malfunction	Malfunction (eg. EEPROM error or probe fault)	
HACCP	HACCP	HACCP function	HACCP function enabled	HACCP alarm (HA and/or HF) not enabled	
	Continuous Cycle	Enabled	Not enabled	Request	

Setting the set point (desired temperature value)

To display or set the set point, proceed as follow:

1. Press the "Set" button for more than 1 second to display the set point.
2. Increase or decrease the value of the set point, using the " *aux*" and " *def*" respectively, until reaching the desired value.
3. Press the "Set" button again to confirm the new value.



Alarms with manual reset

The alarms with manual reset can be reset by pressing the "**Prg**"  and " *aux*" for more than 5 sec.

Manual defrost

As well as the automatic defrost function, a manual defrost can be enabled, if the temperature conditions allow, by pressing the " *def*" button for more than 5 sec.

Continuous cycle

Pressing the buttons " *aux*" and " *def*" simultaneously for more than 5 seconds enables the continuous cycle function. During operation  *aux* in continuous cycle, the compressor continues to operate for the time "cc" and it stops when it reaches the "cc" time out or the minimum temperature has been reached (AL = minimum temperature alarm threshold). Continuous cycle setting: "cc" parameter (continuous cycle duration): "cc"=0 never active; "c6" parameter (by passing the alarm after the continuous cycle): "cc" = 0 never active; it avoid or delays the low temperature alarm after the continuous cycle.

Accessing the configuration parameter (type C)

1. Pressing the "**Prg**"  and "**Set**" buttons at the same time for more than 5 sec, the display will show "00"(password prompt).

Controller Instructions

2. Use the " $\frac{\blacktriangle}{aux}$ " or " $\frac{\blacktriangledown}{def}$ " buttons to display the number "22" (parameter access password).
3. Confirm by pressing "Set".
4. The display will show the first modifiable "C" parameter.

Accessing the configuration parameter (type F)

1. Hold the " $\frac{Prg}{mute}$ " button for more than 5 s (if there are active alarms, first mute the buzzer), the display will show the first modifiable "F" parameter.

Modifying the parameters

After having displayed the parameter, either type "C" or type "F", proceed as follows:

1. Use the " $\frac{\blacktriangle}{aux}$ " or " $\frac{\blacktriangledown}{def}$ " buttons to scroll the parameters, until reaching the parameter to be modified; when scrolling the parameters, an icon is shown on the display that represents the category of the parameter.
2. Alternatively, press the " $\frac{Prg}{mute}$ " button to display a menu that can be used to quickly access the family of parameters to be modified.
3. Scrolling the menu using the " $\frac{\blacktriangle}{aux}$ " and " $\frac{\blacktriangledown}{def}$ " buttons displays the codes of the various categories of parameter, accompanied by the corresponding icon on the display (if present).
4. Once having reached the desired category, press "Set" to go directly to the first parameter in the chosen category (if no parameter is visible, pressing the "Set" button will have no effect).
5. At this stage, modify the parameters or return to the "Category" menu, using the " $\frac{Prg}{mute}$ " button.
6. Press "Set" to display the value associated with the parameter.
7. Increase or decrease the value using the " $\frac{\blacktriangle}{aux}$ " or " $\frac{\blacktriangledown}{def}$ " buttons respectively.
8. Press "Set" to temporarily save the new value and return to the display of the parameter.
9. Repeat the operation from point 1 or point 2.
10. If the parameter has sub-parameters, press "Set" to display the first sub-parameter.
11. Press the " $\frac{\blacktriangle}{aux}$ " or " $\frac{\blacktriangledown}{def}$ " button to display all the sub-parameters.
12. Press "Set" to display the associated value.
13. Increase or decrease the value using the " $\frac{\blacktriangle}{aux}$ " or " $\frac{\blacktriangledown}{def}$ " button respectively.
14. Press "Set" to temporarily save the new value and return to the display of the sub-parameter code.
15. Press " $\frac{Prg}{mute}$ " to return to the display of the parent parameter.

Saving the new values assigned to the parameters

To definitely save the new values of the modified parameters, press the " $\frac{Prg}{mute}$ " button for more than 5 seconds, thus exiting the parameter setting procedure. All the modification made to the parameters temporarily saved in the RAM, can be cancelled and "normal operation" resumed by not pressing any button for 60 seconds, thus allowing the parameter setting session to expire due to timeout if the Instrument is switched off before pressing the " $\frac{Prg}{mute}$ " button, all the modifications made to the parameters and temporarily saved will be lost.

Parts Breakdown

Model RE-CN-0021-HC 50024

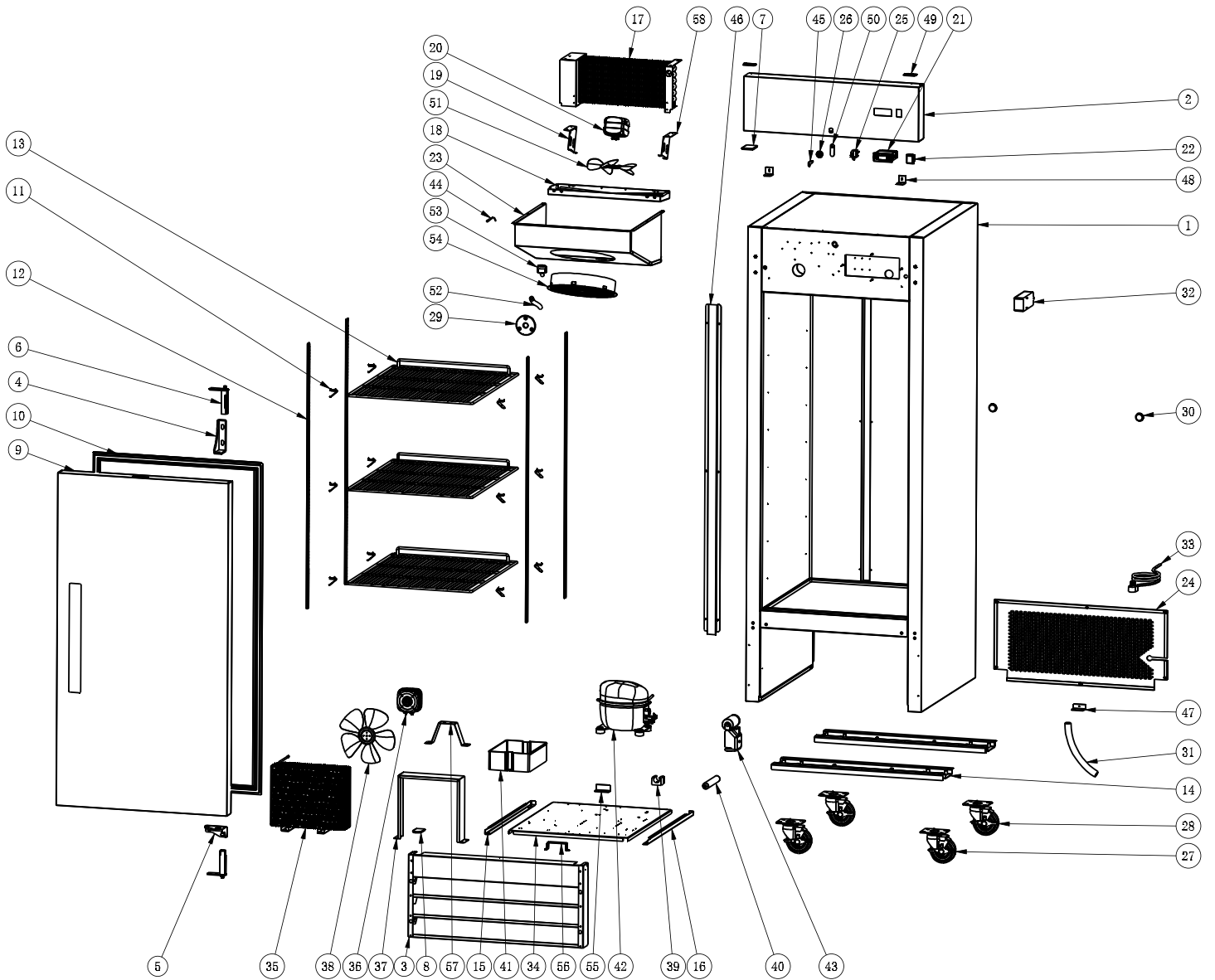

Parts Breakdown

Model RE-CN-0021-HC 50024

Item No.	Description	Position	Item No.	Description	Position	Item No.	Description	Position
AJ129	Cabinet for 50024	1	27185	Carel Temperature Controller PYGX1Z0501 before May 2021 for 50024	21	AB595	Filter Fixer for 50024	39
AJ130	Control Panel for 50024	2	AI375	Dixell Temperature Controller after May 2021 for 50024	21	AB594	Filter D25x160-B for 50024	40
AF027	Front Grill for 50024	3	AA124	Power Switch for 50024	22	AA874	Outer Drain Pan for 50024	41
AA954	Hinge G for 50024	4	AG449	Evaporator Cover for 50024	23	AG454	Compressor for 50024	42
AA956	Hinge H for 50024	5	AG450	Back Grill for 50024	24	AG455	Temperature Sensor of Cabinet Inside for 50024	44
AA955	Left/Right Spring Hinge for 50024	6	AB977	Door Switch for 50024	25	AG462	Baffle of Suction Line for 50024	46
AA972	Bottom Cover for Reversible Door for 50024	7, 8	AA197	Lock for 50024	26, 45	AG463	Back Grill Fixer for 50024	47
AJ131	Door for 50024	9	26246	Caster with Brake for 50024	27	AG464	Control Panel Fixer for 50024	48
AA958	Gasket for 50024	10	26247	Caster without Brake for 50024	28	AA959	Hinge for 50024	49
26884	K Clip for 50024	11	AG451	Drain Plug for 50024	29	AG465	Lock Bolt for 50024	50
AG443	K Strip for 50024	12	AB169	Foaming Hole Cover for 50024	30	AA969	Drain Hose for 50024	52
AG444	Shelf for 50024	13	AA216	Drain Tube for 50024	31	AG466	Elbow Pipe for 50024	53
AF029	Leg Supporter for 50024	14	AA970	Light Components before May 2021 for 50024	32	AG467	Evaporator Fan Motor Cover for 50024	54
AF040	Left Track for Assembling Panel for 50024	15	AJ132	Light Components after May 2021 for 50024	32	AG468	Limited Block of Installation Board for 50024	55
AF041	Right Track For Assembling Panel for 50024	16	AA805	Power Cord for 50024	33	AG469	Compressor Unit Handle for 50024	56
AG445	Evaporator for 50024	17	AG452	Compressor Unit Installation Board for 50024	34	AG470	Condenser Fan Motor Holder for 50024	57
AG446	Inner Drain Pan for 50024	18	AA986	Condenser for 50024	35	AG471	Right Evaporator Fan Motor Holder for 50024	58
AG447	Left Evaporator Fan Motor Holder for 50024	19	AG453	Air Guide Sheet for 50024	37			
AG448	Evaporator Fan Motor for 50024	20, 36	AA764	Condenser/Evaporator Fan Motor Blade for 50024	38, 51			

Parts Breakdown

Model RE-CN-0035-HC 50110

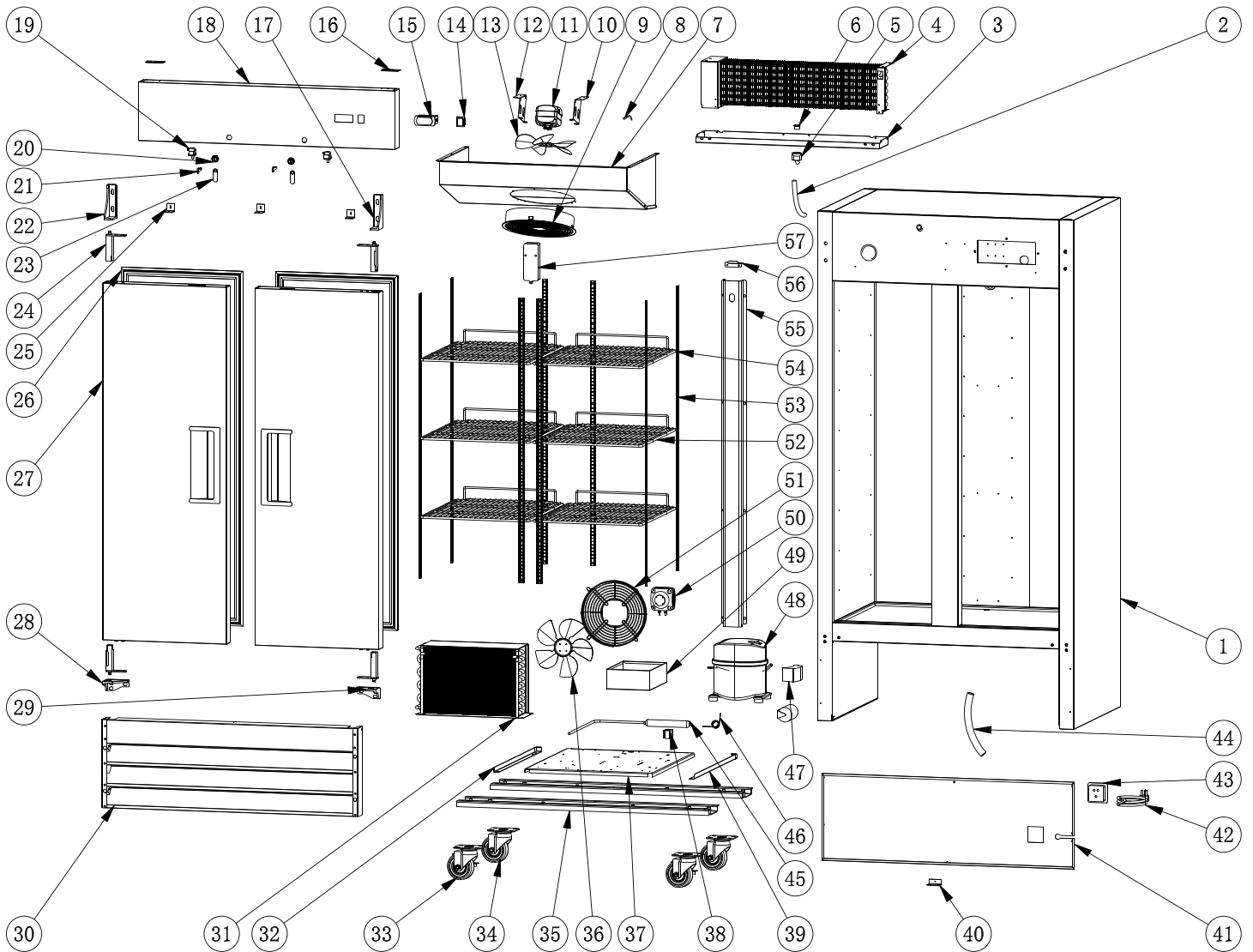

Parts Breakdown

Model RE-CN-0035-HC 50110

Item No.	Description	Position	Item No.	Description	Position	Item No.	Description	Position
AS938	Cabinet for 50110	1	AA197	Lock for 50110	20	AT257	Right Track for Assembling Panel for 50110	39
AA969	Drain Hose for 50110	2	AA196	Key for 50110	21	AF045	Back Grill Fixer for 50110	40
AG552	Inner Drain Pan for 50110	3	AB032	Hinge E for 50110	22	AT258	Back Grill for 50110	41
AN133	Evaporator for 50110	4	AF028	Lock Bolt for 50110	23	AA805	Power Cord for 50110	42
69416	Drain Connector for 50110	5	AA955	Left/Right Spring Hinge for 50110	24	AA216	Drain Tube for 50110	44
AT249	Evaporator Cover for 50110	6	AF026	Control Panel Fixer for 50110	25	AI968	Filter for 50110	45
AT250	Elbow Pipe (Screw) Nut for 50110	7	AT252	Gasket for 50110	26	AT259	Capillary for 50110	46
AG455	Temperature Sensor of Cabinet Inside for 50110	8	AT253	Right Door for 50110	27	AL934	Compressor Starting Kit for 50110	47
AG467	Evaporator Fan Motor Cover for 50110	9	AB033	Hinge F for 50110	28	AF088	Compressor for 50110	48
AG471	Right Evaporator Fan Motor Holder for 50110	10	AA956	Hinge H for 50110	29	AA874	Outer Drain Pan for 50110	49
AG448	Evaporator Fan Motor for 50110	11	AT254	Front Grill for 50110	30	AI963	Condenser Fan Motor for 50110	50
AG447	Left Evaporator Fan Motor Holder for 50110	12	AS737	Condenser for 50110	31	AI960	Condenser Fan Cover for 50110	51
AA764	Condenser/Evaporator Fan Motor Blade for 50110	13	AT255	Left Track for Assembling Panel for 50110	32	AT260	Shelf for 50110	52
AA124	Power Switch for 50110	14	26246	Castor with Brake for 50110	33	AN127	K Strip for 50110	53
27185	Carel Temperature Controller PYGX1Z0501 for 50110	15	26247	Castor without Brake for 50110	34	26884	K Clip for 50110	54
AA959	Hinge for 50110	16	AT256	Leg Support for 50110	35	AT261	Air Pipe Protection Board for 50110	55
AA954	Hinge G for 50110	17	AA962	Blade of Evaporator Fan Motor for 50110	36	AT262	Inner Drain Pan Protection Board for 50110	56
AT251	Control Panel for 50110	18	AF042	Compressor Unit Installation Board for 50110	37	AJ132	Light Components for 50110	57
AA844	Door Switch for 50110	19	AB595	Filter Fixer for 50110	38	AT263	Brass Spacer on the Bottom Hinge for 50110	58

Parts Breakdown

Model RE-CN-0041-HC 50026

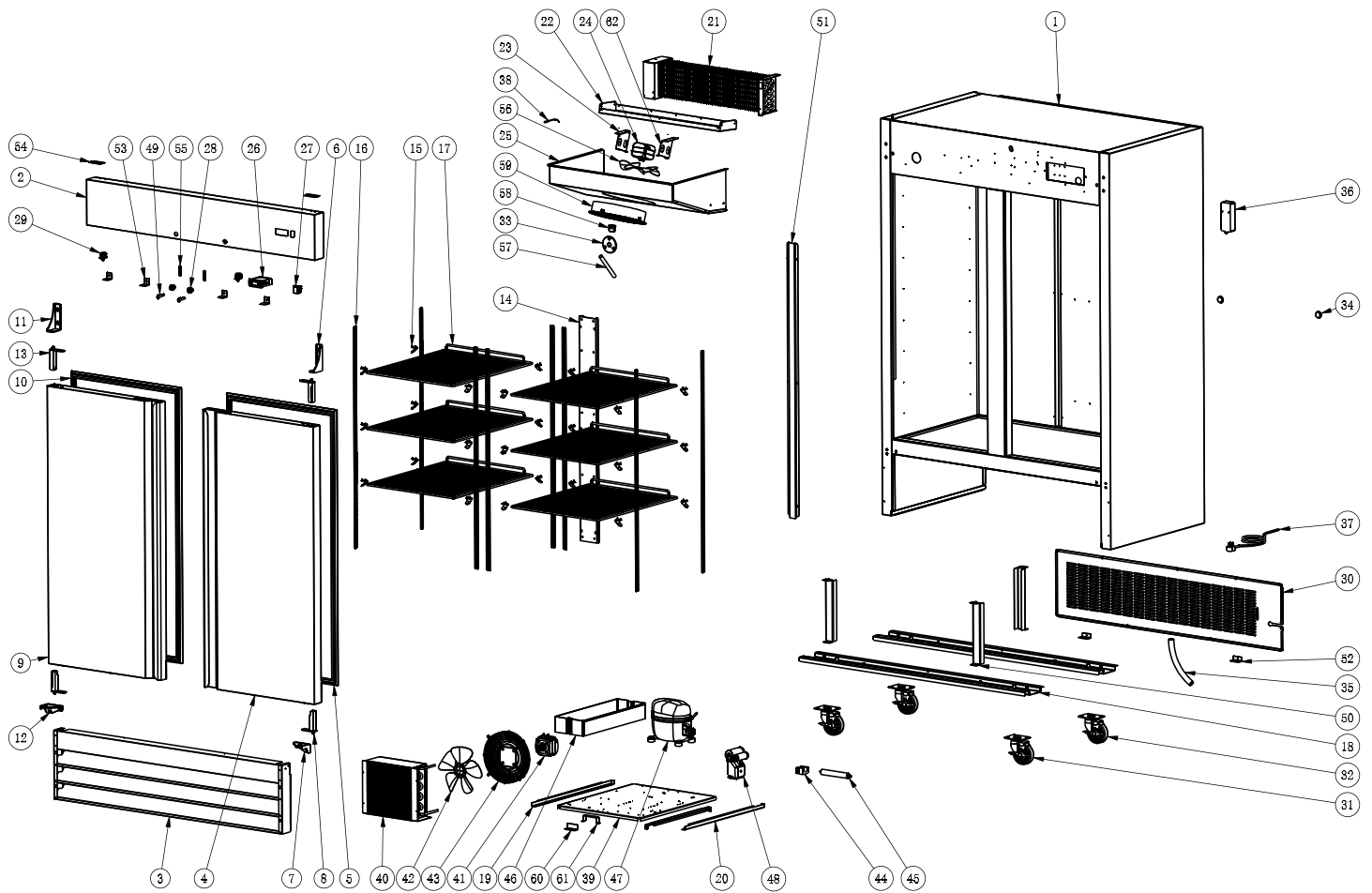

Parts Breakdown

Model RE-CN-0041-HC 50026

Item No.	Description	Position	Item No.	Description	Position	Item No.	Description	Position
AJ133	Cabinet for 50026	1	AG447	Left Evaporator Fan Motor Holder for 50026	23	AA764	Condenser/Evaporator Fan Motor Blade for 50026	42, 56
AJ134	Control Panel for 50026	2	AG448	Evaporator Fan Motor for 50026	24, 41	AG556	Condenser Fan Cover for 50026	43
AF048	Front Grill for 50026	3	AG553	Evaporator Cover for 50026	25	AB595	Filter Fixer for 50026	44
AJ135	Right Door for 50026	4	27185	Carel Temperature Controller PYGX1Z0501 before May 2021 for 50026	26	AB594	Filter D25x160-B for 50026	45
AB029	Gasket for 50026	5, 10	AI375	Dixell Temperature Controller after May 2021 for 50026	26	AA874	Outer Drain Pan for 50026	46
AA954	Hinge G for 50026	6	AA124	Power Switch for 50026	27	AE915	Compressor (T6217Z) for 50026	47
AA956	Hinge H for 50026	7	AA197	Lock for 50026	28, 49	AG557	Parts of Compressor for 50026	48
AA955	Left/Right Spring Hinge for 50026	8, 13	AB977	Door Switch for 50026	29	AG558	Cabinet Supporter for 50026	50
AJ136	Left Door for 50026	9	AG554	Back Grill for 50026	30	AG462	Baffle of Suction Line for 50026	51
AB032	Hinge E for 50026	11	26246	Caster with Brake for 50026	31	AG463	Back Grill Fixer for 50026	52
AB033	Hinge F for 50026	12	26247	Caster without Brake for 50026	32	AG464	Control Panel Fixer for 50026	53
AG550	Back Brackets for 50026	14	AG451	Drain Plug for 50026	33	AA959	Hinge for 50026	54
26884	K Clip for 50026	15	AB169	Foaming Hole Cover for 50026	34	AG465	Lock Bolt for 50026	55
AG443	K Strip for 50026	16	AA216	Drain Tube for 50026	35	AA969	Drain Hose for 50026	57
AG444	Shelf for 50026	17	AA970	Light Components before May 2021 for 50026	36	AG466	Elbow Pipe for 50026	58
61471	Leg Supporter for 50026	18	AJ132	Light Components after May 2021 for 50026	36	AG467	Evaporator Fan Motor Cover for 50026	59
AF040	Left Track for Assembling Panel for 50026	19	AA805	Power Cord for 50026	37	AG468	Limited Block of Installation Board for 50026	60
AF041	Right Track for Assembling Panel for 50026	20	AG455	Temperature Sensor of Cabinet Inside for 50026	38	AG469	Compressor Unit Handle for 50026	61
AG551	Evaporator New Style 4R7K620L (Dia -7.94) for 50026	21	AG452	Compressor Unit Installation Board for 50026	39	AG471	Right Evaporator Fan Motor Holder for 50026	62
AG552	Inner Drain Pan for 50026	22	AG555	Condenser for 50026	40			

Parts Breakdown

Model RE-CN-0067-HC 50028

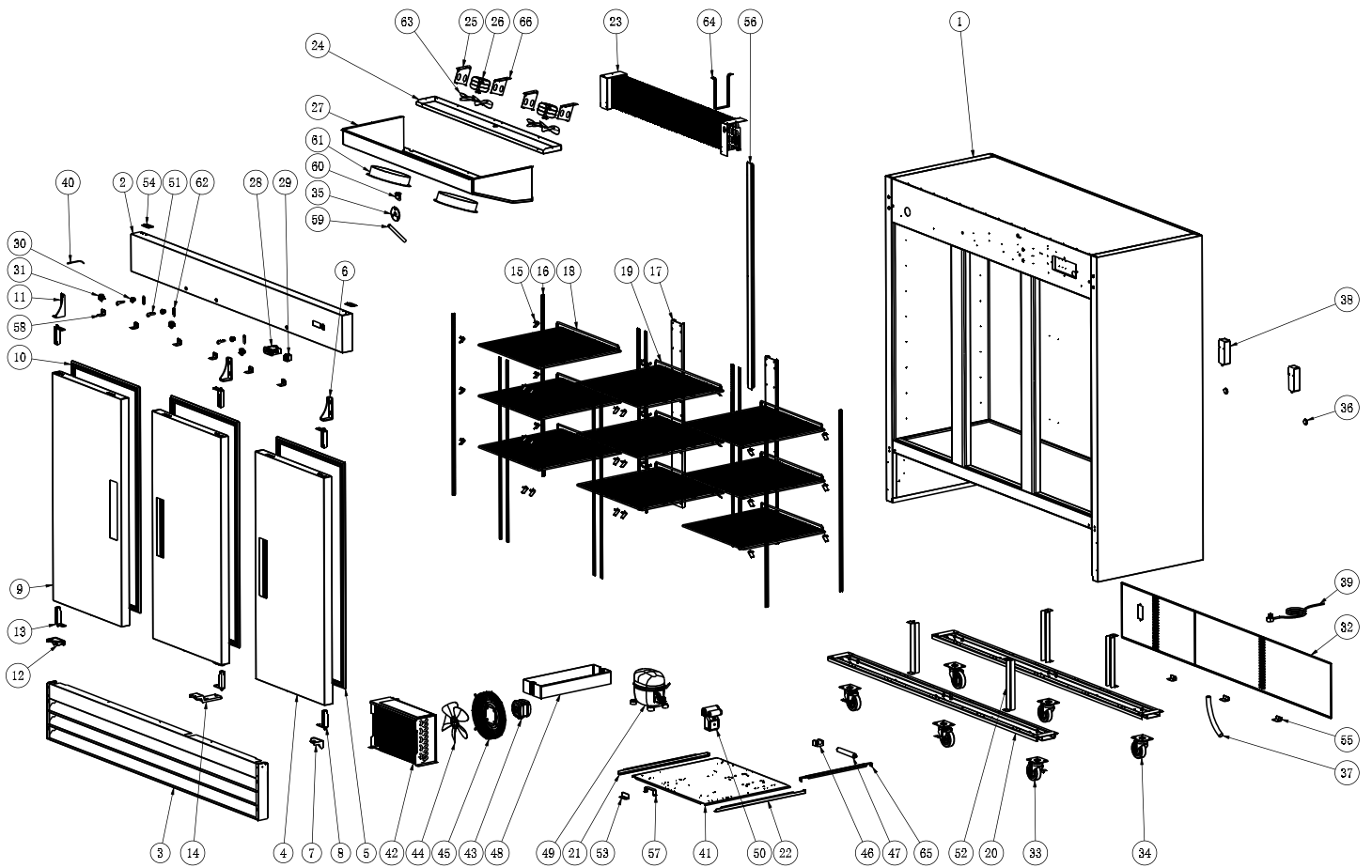

Parts Breakdown

Model RE-CN-0067-HC 50028

Item No.	Description	Position	Item No.	Description	Position	Item No.	Description	Position
AJ147	Cabinet for 50028	1	AG569	Inner Drain Pan for 50028	24	AA764	Condenser/Evaporator Fan Motor Blade for 50028	44, 63
AJ148	Control Panel for 50028	2	AG447	Left Evaporator Fan Motor Holder for 50028	25	AG556	Condenser Fan Cover for 50028	45
AF060	Front Grill for 50028	3	AG448	Evaporator Fan Motor for 50028	26, 43	AB595	Filter Fixer for 50028	46
AJ135	Right Door for 50028	4	AG570	Evaporator Cover for 50028	27	AB594	Filter D25x160-B for 50028	47
AA954	Hinge G for 50028	6	27185	Carel Temperature Controller PYGX1Z0501 before May 2021 for 50028	28	AB970	Outer Drain Pan for 50028	48
AB029	Gasket for 50028	5, 10	AI375	Dixell Temperature Controller after May 2021 for 50028	28	AG573	Compressor for 50028	49
AA956	Hinge H for 50028	7	AA124	Power Switch for 50028	29	AG558	Cabinet Supporter for 50028	52
AA955	Left/Right Spring Hinge for 50028	8, 13	AA197	Lock for 50028	30, 51	AG468	Limited Block of Installation Board for 50028	53
AJ136	Left Door for 50028	9	AB977	Door Switch for 50028	31	AA959	Hinge for 50028	54
AB032	Hinge E for 50028	11	AG571	Back Grill for 50028	32	AG463	Back Grill Fixer for 50028	55
AB033	Hinge F for 50028	12	26246	Caster with Brake for 50028	33	AG462	Baffle of Suction Line for 50028	56
AB090	Middle Hinge C for 50028	14	26247	Caster without Brake for 50028	34	AG469	Compressor Unit Handle for 50028	57
26884	K Clip for 50028	15	AG451	Drain Plug for 50028	35	AG464	Control Panel Fixer for 50028	58
AG443	K Strip for 50028	16	AB169	Foaming Hole Cover for 50028	36	AA969	Drain Hose for 50028	59
AG550	Back Brackets for 50028	17	AA216	Drain Tube for 50028	37	AG466	Elbow Pipe for 50028	60
AG444	Shelf for 50028	18	AA970	Light Components before May 2021 for 50028	38	AG467	Evaporator Fan Motor Cover for 50028	61
AG567	Middle Shelf for 50028	19	AJ132	Light Components after May 2021 for 50028	38	AG465	Lock Bolt for 50028	62
AF061	Leg Supporter for 50028	20	AA805	Power Cord for 50028	39	AG574	Defrost Heater Fixer for 50028	64
AF040	Left Track for Assembling Panel for 50028	21	AG455	Temperature Sensor of Cabinet Inside for 50028	40	AG575	Auxiliary Track for 50028	65
AF041	Right Track for Assembling Panel for 50028	22	AG572	Compressor Unit Installation Board for 50028	41	AG471	Right Evaporator Fan Motor Holder for 50028	66
AG568	Evaporator for 50028	23	AG555	Condenser for 50028	42			

Parts Breakdown

Model FR-CN-0737-HC 50023

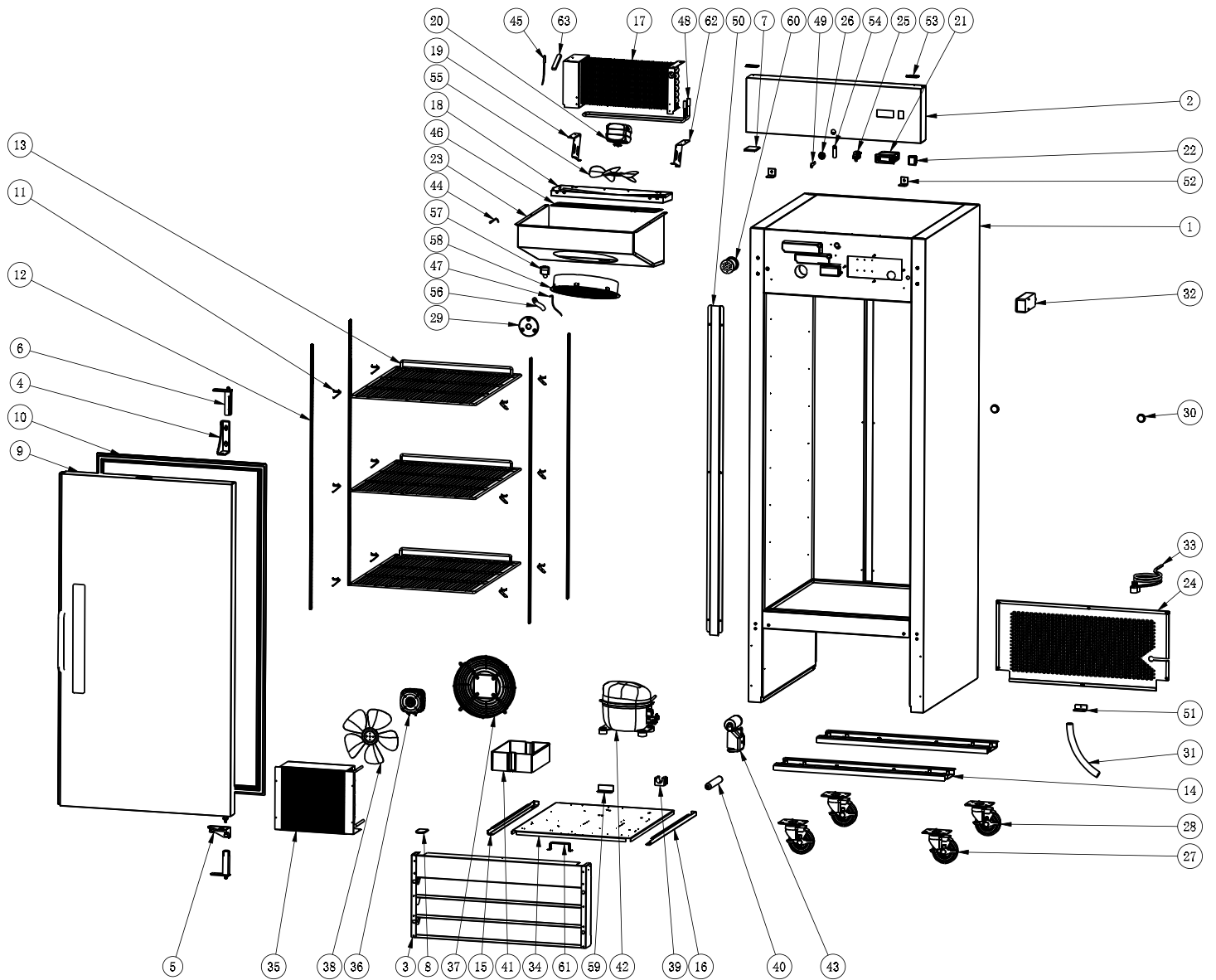

Parts Breakdown

Model FR-CN-0737-HC 50023

Item No.	Description	Position	Item No.	Description	Position	Item No.	Description	Position
AJ129	Cabinet for 50023	1	AI322	Dixell Temperature Controller - XRO6CX-4N1F1 after May 2021 for 50023	21	AA874	Outer Drain Pan for 50023	41
AJ130	Control Panel for 50023	2	AA124	Power Switch for 50023	22	AJ150	Compressor for 50023	42
AF027	Front Grill for 50023	3	AG449	Evaporator Cover for 50023	23	AG455	Temperature Sensor of Cabinet Inside for 50023	44
AA954	Hinge G for 50023	4	AG450	Back Grill for 50023	24	AJ151	Evaporator Temperature Sensor for 50023	45
AA956	Hinge H for 50023	5	AB977	Door Switch for 50023	25	AJ152	Drain Pan Heater for 50023	46
AA955	Left/Right Spring Hinge for 50023	6	AA197	Lock for 50023	26, 49	AJ153	Drain Hose Heater for 50023	47
AA972	Bottom Cover for Reversible Door for 50023	7, 8	26246	Caster with Brake for 50023	27	AJ154	Defrost Heater for 50023	48
AJ131	Door for 50023	9	26247	Caster without Brake for 50023	28	AG462	Baffle of Suction Line for 50023	50
AA958	Gasket for 50023	10	AG451	Drain Plug for 50023	29	AG463	Back Grill Fixer for 50023	51
26884	K Clip for 50023	11	AB169	Foaming Hole Cover for 50023	30	AG464	Control Panel Fixer for 50023	52
AG443	K Strip for 50023	12	AA216	Drain Tube for 50023	31	AA959	Hinge for 50023	53
AG444	Shelf for 50023	13	AA970	Light Components before May 2021 for 50023	32	AG465	Lock Bolt for 50023	54
AF029	Leg Supporter for 50023	14	AJ132	Light Components after May 2021 for 50023	32	AA969	Drain Hose for 50023	56
AF040	Left Track for Assembling Panel for 50023	15	AA805	Power Cord for 50023	33	AG466	Elbow Pipe for 50023	57
AF041	Right Track for Assembling Panel for 50023	16	AG452	Compressor Unit Installation Board for 50023	34	AG467	Evaporator Fan Motor Cover for 50023	58
AJ149	Evaporator for 50023	17	AG555	Condenser for 50023	35	AG468	Limited Block of Installation Board for 50023	59
AG446	Inner Drain Pan for 50023	18	AG556	Condenser Fan Cover for 50023	37	AJ155	Decompression Valve for 50023	60
AG447	Left Evaporator Fan Motor Holder for 50023	19	AA764	Condenser/Evaporator Fan Motor Blade for 50023	38, 55	AG469	Compressor Unit Handle for 50023	61
AG448	Evaporator Fan Motor for 50023	20, 36	AB595	Filter Fixer for 50023	39	AG471	Right Evaporator Fan Motor Holder for 50023	62
27186	Carel Temperature Controller IR33 before May 2021 for 50023	21	AB594	Filter D25x160-B for 50023	40	AJ156	Fuse for Defrost Heater for 50023	63

Parts Breakdown

Model FR-CN-0035-HC 50111

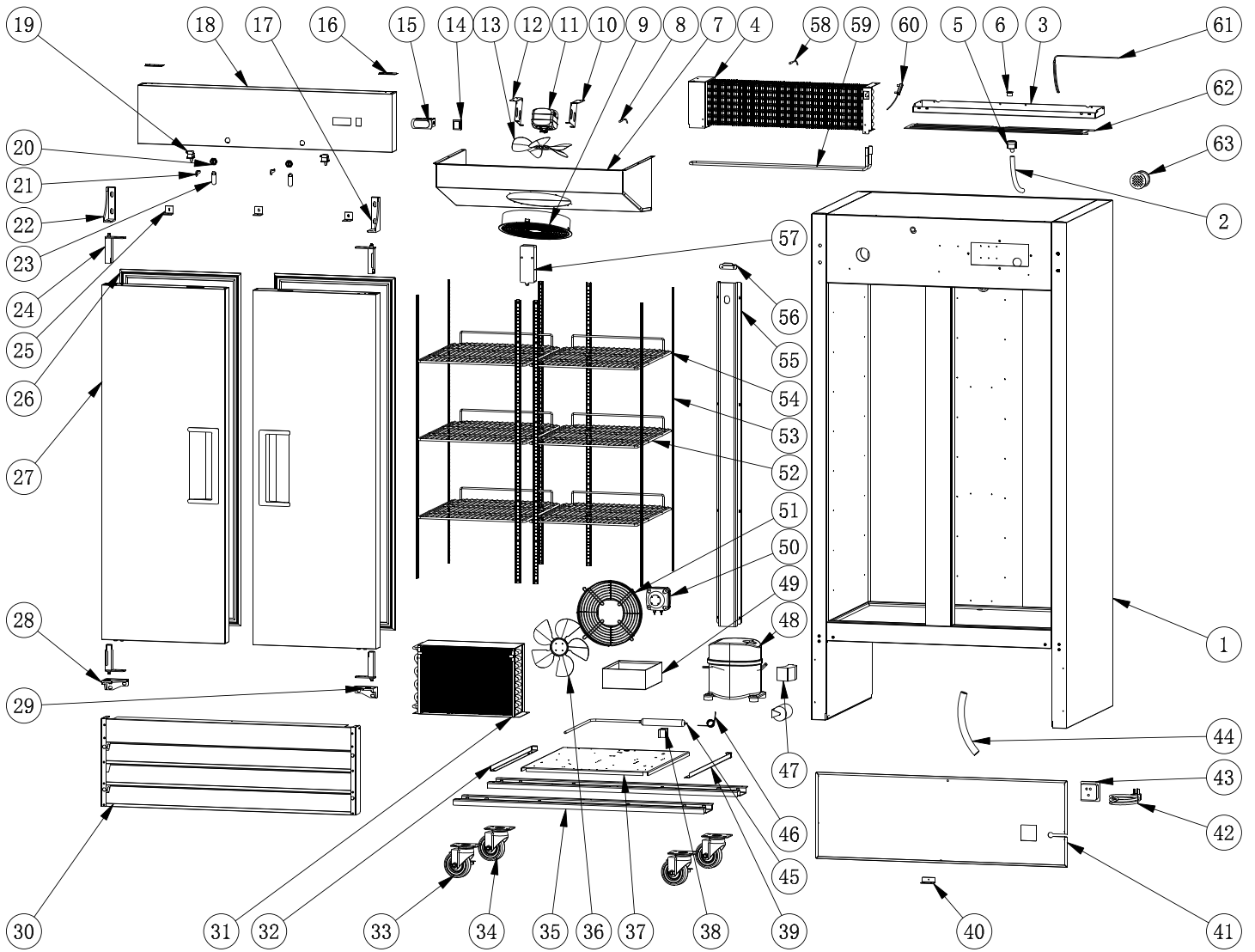

Parts Breakdown

Model FR-CN-0035-HC 50111

Item No.	Description	Position	Item No.	Description	Position	Item No.	Description	Position
AT274	Cabinet for 50111	1	AB032	Hinge E for 50111	22	AA216	Drain Tube for 50111	44
AA969	Drain Hose for 50111	2	AF028	Lock Bolt for 50111	23	AI968	Filter for 50111	45
AG552	Inner Drain Pan for 50111	3	AA955	Left/Right Spring Hinge for 50111	24	AT259	Capillary for 50111	46
AJ157	Evaporator for 50111	4	AF026	Control Panel Fixer for 50111	25	AT275	Compressor for 50111	47
69416	Drain Connector for 50111	5	AT252	Gasket for 50111	26	AT276	Compressor for 50111	48
AT249	Evaporator Cover for 50111	6	AT253	Right Door for 50111	27	AA874	Outer Drain Pan for 50111	49
AT250	Elbow Pipe (Screw) Nut for 50111	7	AB033	Hinge F for 50111	28	AI963	Condenser Fan Motor for 50111	50
AG455	Temperature Sensor of Cabinet Inside for 50111	8	AA956	Hinge H for 50111	29	AI960	Condenser Fan Cover for 50111	51
AG467	Evaporator Fan Motor Cover for 50111	9	AT254	Front Grill for 50111	30	AT260	Shelf for 50111	52
AG471	Right Evaporator Fan Motor Holder for 50111	10	AS737	Condenser for 50111	31	AN127	K Strip for 50111	53
AG448	Evaporator Fan Motor for 50111	11	AT255	Left Track for Assembling Panel for 50111	32	26884	K Clip for 50111	54
AG447	Left Evaporator Fan Motor Holder for 50111	12	26246	Castor with Brake for 50111	33	AT261	Air Pipe Protection Board for 50111	55
AA764	Condenser/Evaporator Fan Motor Blade for 50111	13	26247	Castor without Brake for 50111	34	AT262	Inner Drain Pan Protection Board for 50111	56
AA124	Power Switch for 50111	14	AT256	Leg Supporter for 50111	35	AJ132	Light Components for 50111	57
26483	Carel Temperature Controller - PYGXAZ0586 for 50111	15	AA962	Blade of Evaporator Fan Motor for 50111	36	AJ151	Evaporator Temperature Sensor for 50111	58
AA959	Hinge for 50111	16	AF042	Compressor Unit Installation Board for 50111	37	AJ162	Defrost Heater for 50111	59
AA954	Hinge G for 50111	17	AB595	Filter Fixer for 50111	38	AJ156	Fuse for Defrost Heater for 50111	60
AT251	Control Panel for 50111	18	AT257	Right Track for Assembling Panel for 50111	39	AM512	Drain Hose Heater for 50111	61
AA844	Door Switch for 50111	19	AF045	Back Grill Fixer for 50111	40	AT277	Drain Pan Heater for 50111	62
AA197	Lock for 50111	20	AT258	Back Grill for 50111	41	AJ155	Decompression Valve for 50111	63
AA196	Key for 50111	21	AA805	Power Cord for 50111	42	AT263	Brass Spacer on the Bottom Hinge for 50111	64

Parts Breakdown

Model FR-CN-1372-HC 50025

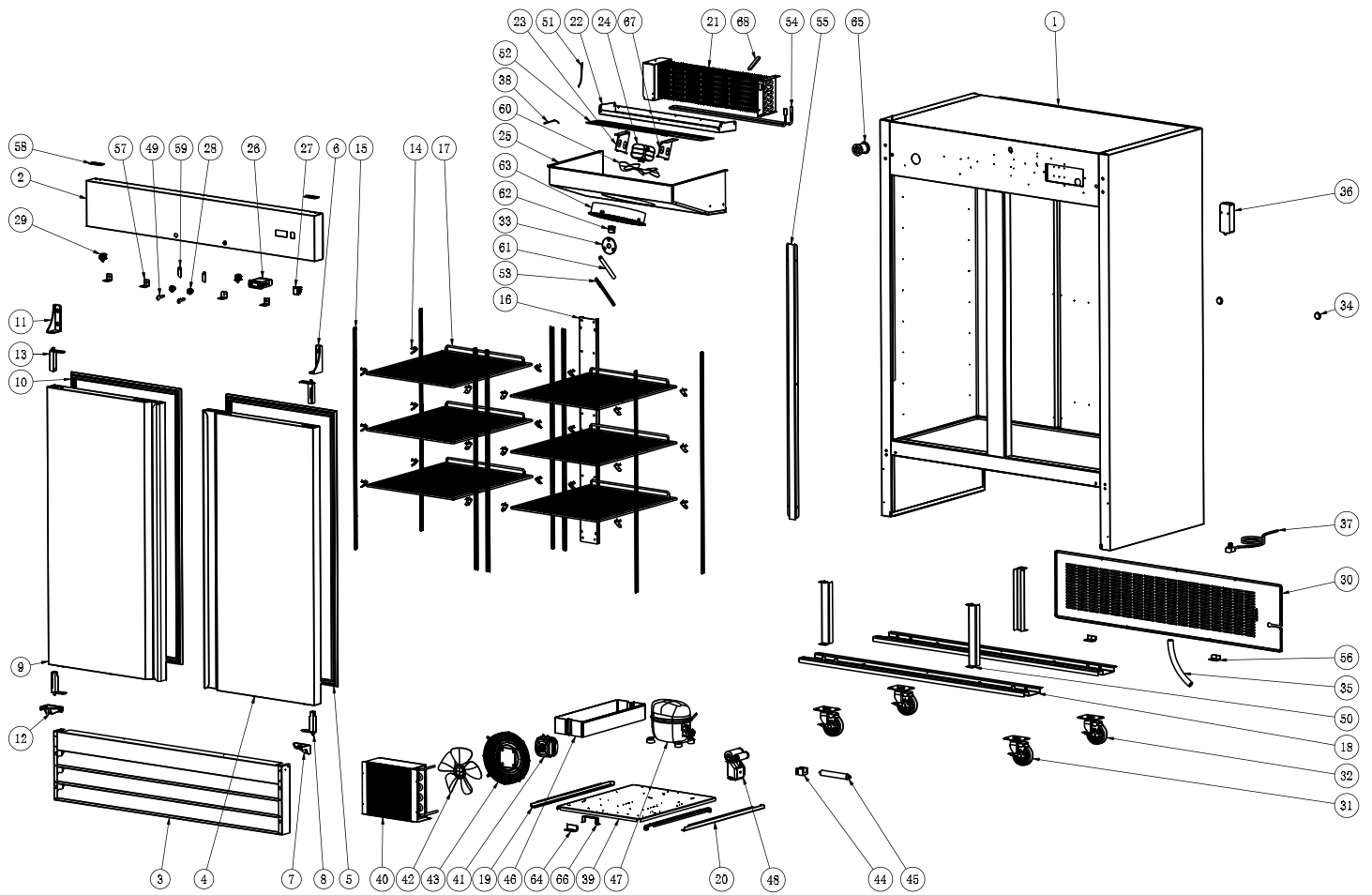

Parts Breakdown

Model FR-CN-1372-HC 50025

Item No.	Description	Position	Item No.	Description	Position	Item No.	Description	Position
AJ133	Cabinet for 50025	1	27186	Carel Temperature Controller IR33 before May 2021 for 50025	26	AJ159	Compressor for 50025	47
AJ134	Control Panel for 50025	2	AI322	Dixell Temperature Controller - XR06CX-4N1F1 after May 2021 for 50025	26	AJ160	Parts of Compressor for 50025	48
AF048	Front Grill for 50025	3	AA124	Power Switch for 50025	27	AG558	Cabinet Supporter for 50025	50
AJ135	Right Door for 50025	4	AA197	Lock for 50025	28, 49	AJ151	Evaporator Temperature Sensor for 50025	51
AB029	Gasket for 50025	5, 10	AB977	Door Switch for 50025	29	AJ161	Drain Pan Heater for 50025	52
AA954	Hinge G for 50025	6	AG554	Back Grill for 50025	30	AJ153	Drain Hose Heater for 50025	53
AA956	Hinge H for 50025	7	26246	Caster with Brake for 50025	31	AJ162	Defrost Heater for 50025	54
AA955	Left/Right Spring Hinge for 50025	8, 13	26247	Caster without Brake for 50025	32	AG462	Baffle of Suction Line for 50025	55
AJ136	Left Door for 50025	9	AG451	Drain Plug for 50025	33	AG463	Back Grill Fixer for 50025	56
AB032	Hinge E for 50025	11	AB169	Foaming Hole Cover for 50025	34	AG464	Control Panel Fixer for 50025	57
AB033	Hinge F for 50025	12	AA216	Drain Tube for 50025	35	AA959	Hinge for 50025	58
26884	K Clip for 50025	14	AA970	Light Components before May 2021 for 50025	36	AG465	Lock Bolt for 50025	59
AG443	K Strip for 50025	15	AJ132	Light Components after May 2021 for 50025	36	AA764	Condenser/Evaporator Fan Motor Blade for 50025	60
AG550	Back Brackets for 50025	16	AA805	Power Cord for 50025	37	AA969	Drain Hose for 50025	61
AG444	Shelf for 50025	17	AG455	Temperature Sensor of Cabinet Inside for 50025	38	AG466	Elbow Pipe for 50025	62
61471	Leg Supporter for 50025	18	AG452	Compressor Unit Installation Board for 50025	39	AG467	Evaporator Fan Motor Cover for 50025	63
AF040	Left Track for Assembling Panel for 50025	19	AH690	Condenser for 50025	40	AG468	Limited Block of Installation Board for 50025	64
AF041	Right Track for Assembling Panel for 50025	20	AJ158	Condenser Fan Motor for 50025	41	AJ155	Decompression Valve for 50025	65
AJ157	Evaporator for 50025	21	AA814	Condenser Fan Motor Blade for 50025	42	AG469	Compressor Unit Handle for 50025	66
AG552	Inner Drain Pan for 50025	22	AB077	Condenser Fan Cover for 50025	43	AG471	Right Evaporator Fan Motor Holder for 50025	67
AG447	Left Evaporator Fan Motor Holder for 50025	23	AB595	Filter Fixer for 50025	44	AJ156	Fuse for Defrost Heater for 50025	68
AG448	Evaporator Fan Motor for 50025	24	AB594	Filter D25x160-B for 50025	45	AI007	Complete Middle Beam with Heater for 50025	
AG553	Evaporator Cover for 50025	25	AB970	Outer Drain Pan for 50025	46			

Parts Breakdown

Model **FR-CN-2057-HC** 50027

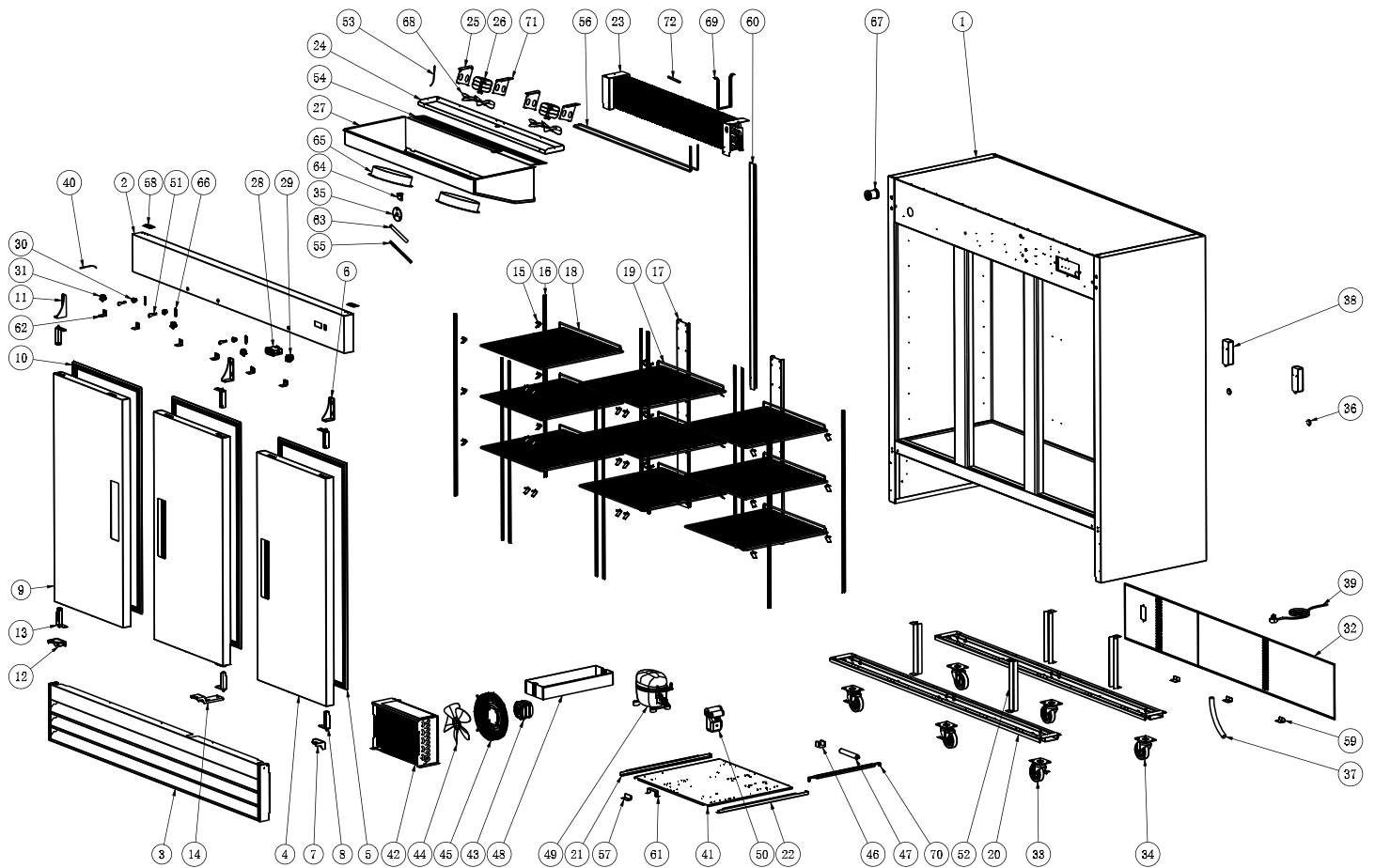



Parts Breakdown

Model FR-CN-2057-HC 50027

Item No.	Description	Position	Item No.	Description	Position	Item No.	Description	Position
AJ147	Cabinet for 50027	1	AG570	Evaporator Cover for 50027	27	AF067	Compressor for 50027	49
AJ148	Control Panel for 50027	2	27186	Carel Temperature Controller IR33 before May 2021 for 50027	28	AJ163	Parts of Compressor for 50027	50
AF060	Front Grill for 50027	3	AI322	Dixell Temperature Controller - XRO6CX-4N1F1 after May 2021 for 50027	28	AG558	Cabinet Supporter for 50027	52
AJ135	Right Door for 50027	4	AA124	Power Switch for 50027	29	AJ151	Evaporator Temperature Sensor for 50027	53
AB029	Gasket for 50027	5, 10	AA197	Lock for 50027	30, 51	AH707	Drain Pan Heater for 50027	54
AA954	Hinge G for 50027	6	AB977	Door Switch for 50027	31	AJ153	Drain Hose Heater for 50027	55
AA956	Hinge H for 50027	7	AG571	Back Grill for 50027	32	AH705	Defrost Heater for 50027	56
AA955	Left/Right Spring Hinge for 50027	8, 13	26246	Caster with Brake for 50027	33	AG468	Limited Block of Installation Board for 50027	57
AJ136	Left Door for 50027	9	26247	Caster without Brake for 50027	34	AA959	Hinge for 50027	58
AB032	Hinge E for 50027	11	AG451	Drain Plug for 50027	35	AG463	Back Grill Fixer for 50027	59
AB033	Hinge F for 50027	12	AB169	Foaming Hole Cover for 50027	36	AG462	Baffle of Suction Line for 50027	60
AB090	Middle Hinge C for 50027	14	AA216	Drain Tube for 50027	37	AG469	Compressor Unit Handle for 50027	61
26884	K Clip for 50027	15	AA970	Light Components before May 2021 for 50027	38	AG464	Control Panel Fixer for 50027	62
AG443	K Strip for 50027	16	AJ132	Light Components after May 2021 for 50027	38	AA969	Drain Hose for 50027	63
AG550	Back Brackets for 50027	17	AA927	Power Cord for 50027	39	AG466	Elbow Pipe for 50027	64
AG444	Shelf for 50027	18	AG455	Temperature Sensor of Cabinet Inside for 50027	40	AG467	Evaporator Fan Motor Cover for 50027	65
AG567	Middle Shelf for 50027	19	AG572	Compressor Unit Installation Board for 50027	41	AG465	Lock Bolt for 50027	66
AF061	Leg Supporter for 50027	20	AH690	Condenser for 50027	42	AJ155	Decompression Valve for 50027	67
AF040	Left Track for Assembling Panel for 50027	21	AJ158	Condenser Fan Motor for 50027	43	AA764	Condenser/Evaporator Fan Motor Blade for 50027	68
AF041	Right Track for Assembling Panel for 50027	22	AA814	Condenser Fan Motor Blade for 50027	44	AG574	Defrost Heater Fixer for 50027	69
AG568	Evaporator for 50027	23	AB077	Condenser Fan Cover for 50027	45	AG575	Auxiliary Track for 50027	70
AG569	Inner Drain Pan for 50027	24	AB595	Filter Fixer for 50027	46	AG471	Right Evaporator Fan Motor Holder for 50027	71
AG447	Left Evaporator Fan Motor Holder for 50027	25	AB594	Filter D25x160-B for 50027	47	AJ156	Fuse for Defrost Heater for 50027	72
AG448	Evaporator Fan Motor for 50027	26	AB970	Outer Drain Pan for 50027	48	AP020	Complete Middle Beam with Heater for 50027	

Electrical Schematics

Model RE-CN-0021-HC 50024

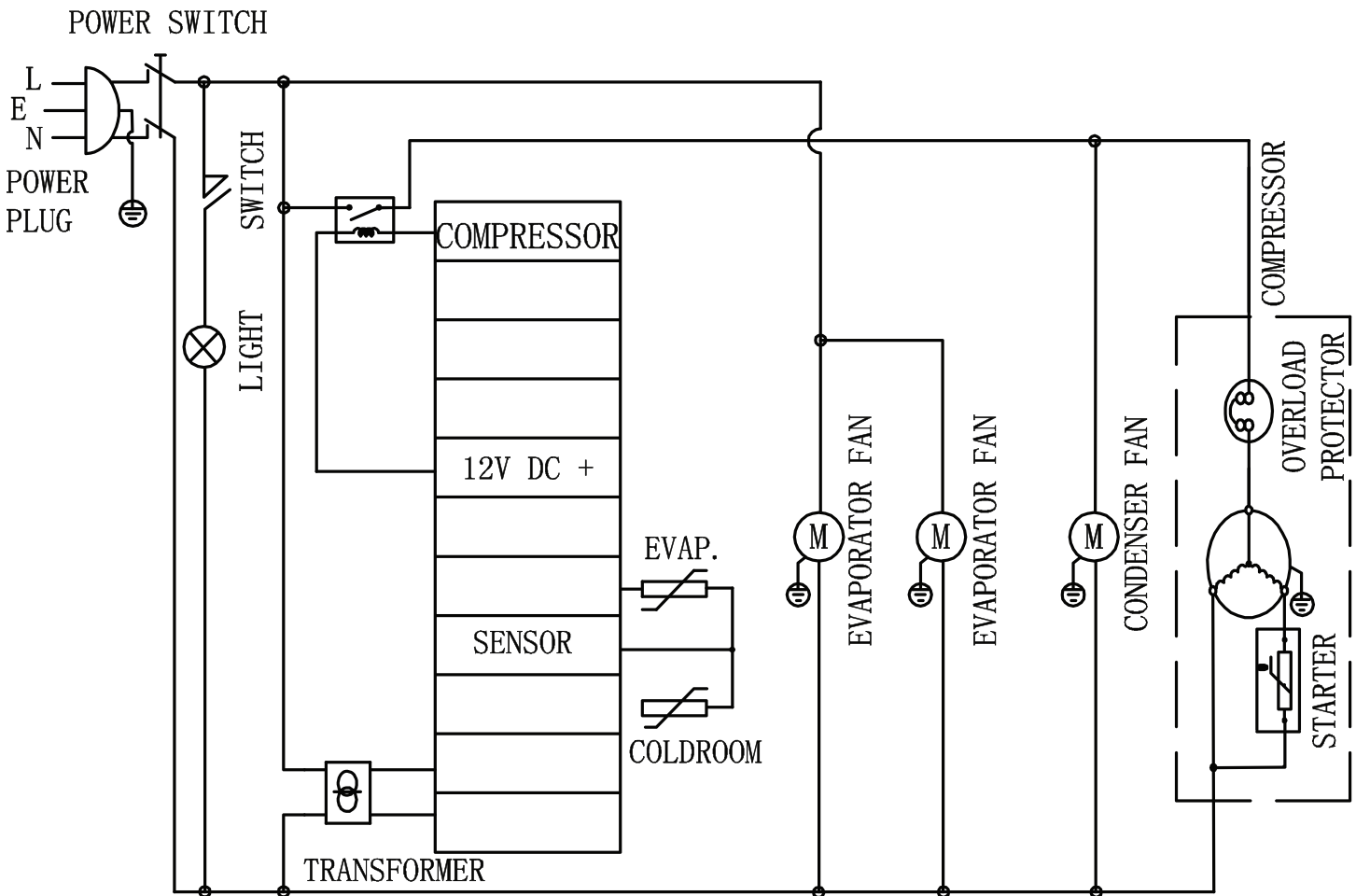

NEMA
5 - 15P
125VAC / 15 AMP

Electrical Schematics

Model RE-CN-0035-HC 50110

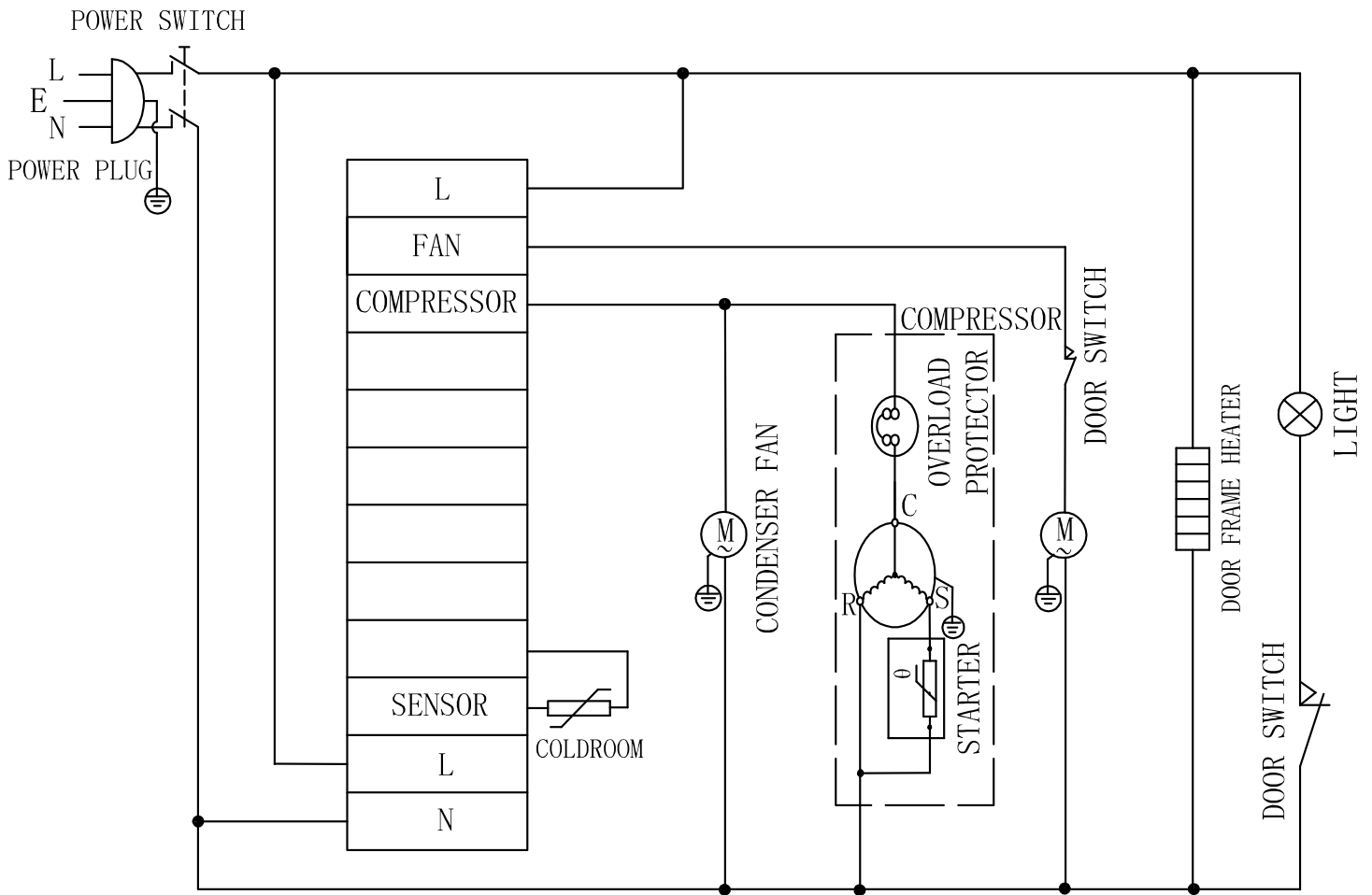

NEMA
 5 - 15P
 125VAC / 15 AMP

Electrical Schematics

Model RE-CN-0041-HC 50026

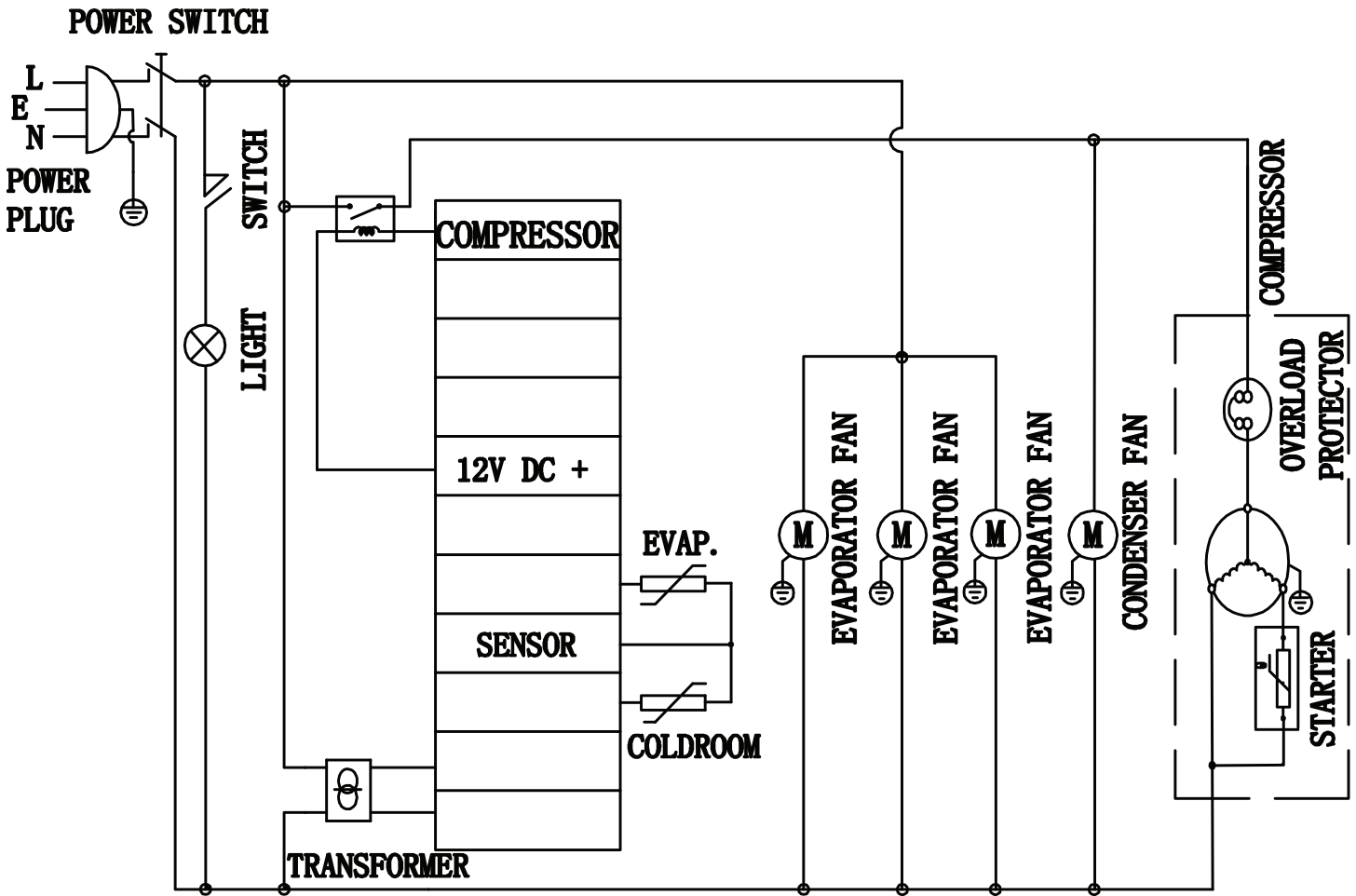

NEMA
5 - 15P
125VAC / 15 AMP

Electrical Schematics

Model FR-CN-0737-HC 50023

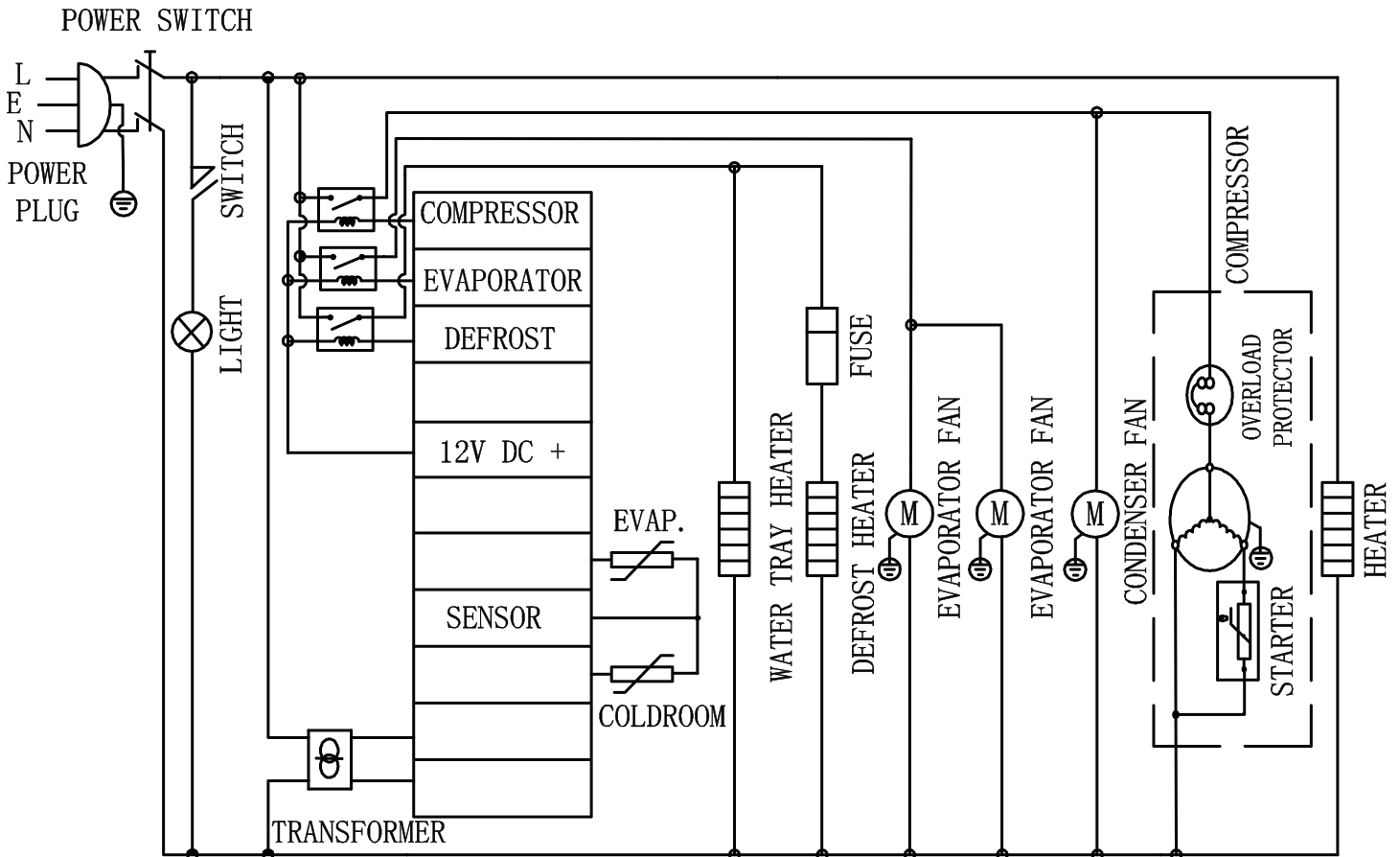

NEMA
5 - 20P
125VAC / 20 AMP

Electrical Schematics

Model FR-CN-0035-HC 50111

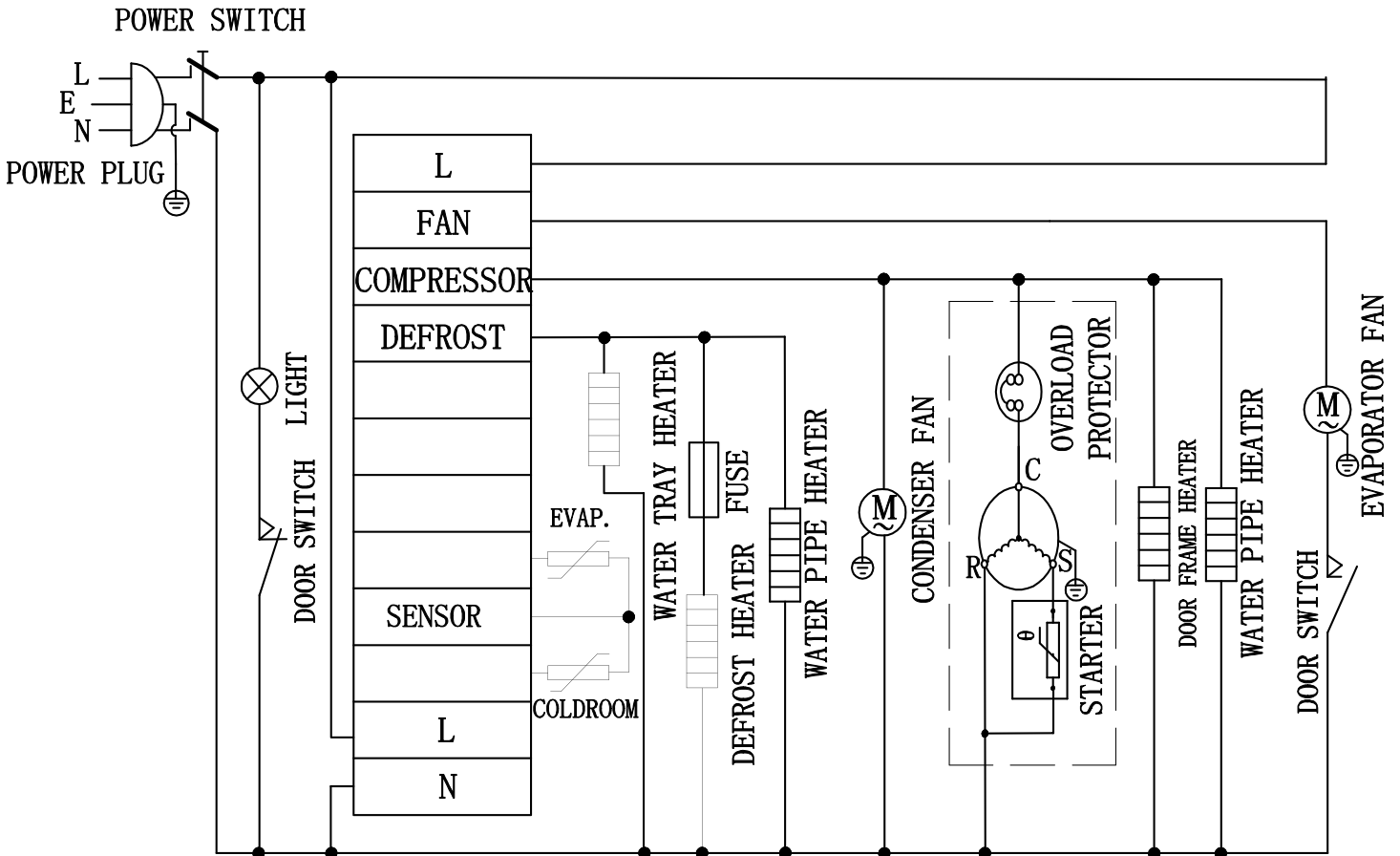

NEMA
 5 - 20P
 125VAC / 20 AMP

Electrical Schematics

Model **FR-CN-1372-HC** 50025

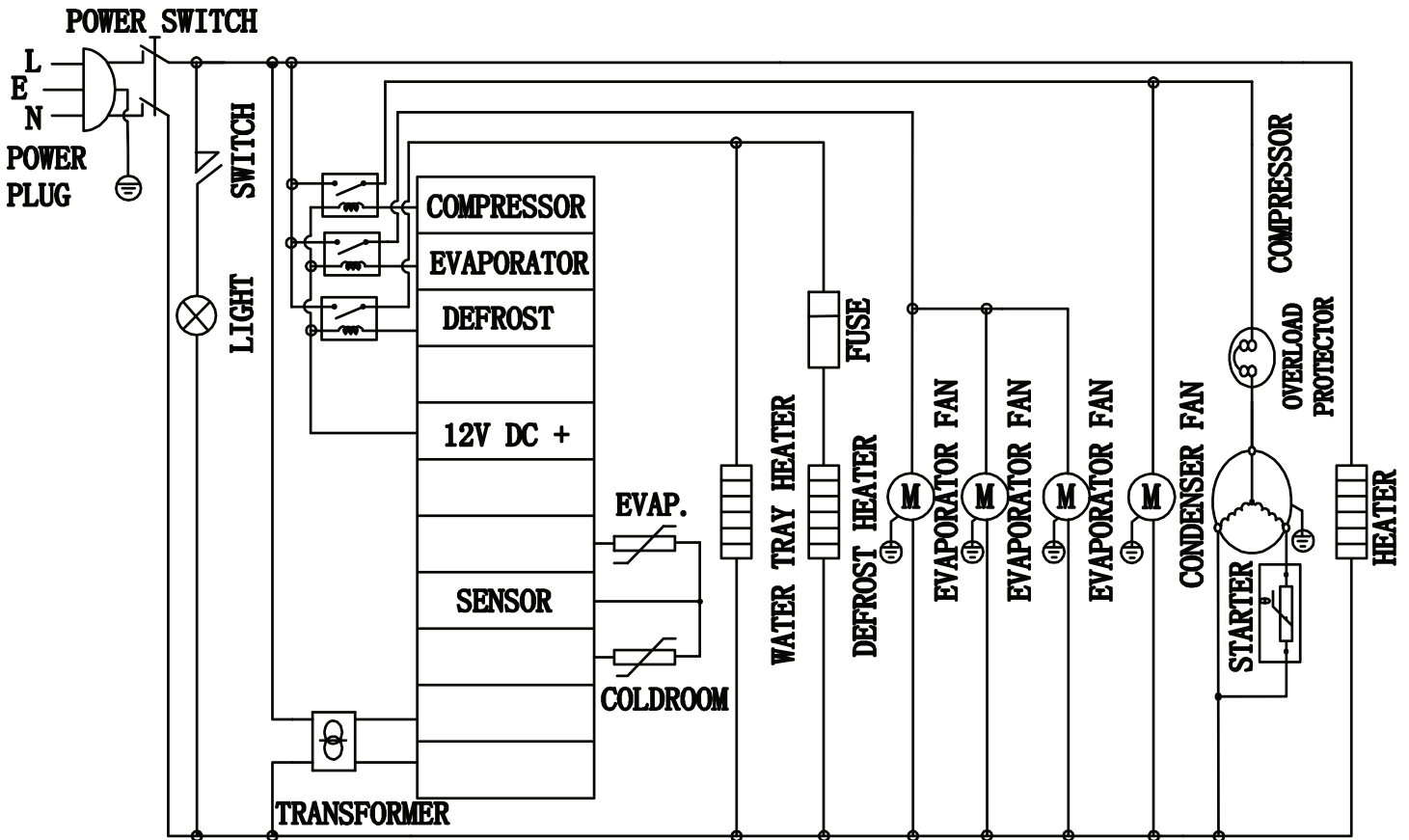

NEMA
5 - 20P
125VAC / 20 AMP

Electrical Schematics

Model FR-CN-2057-HC 50027

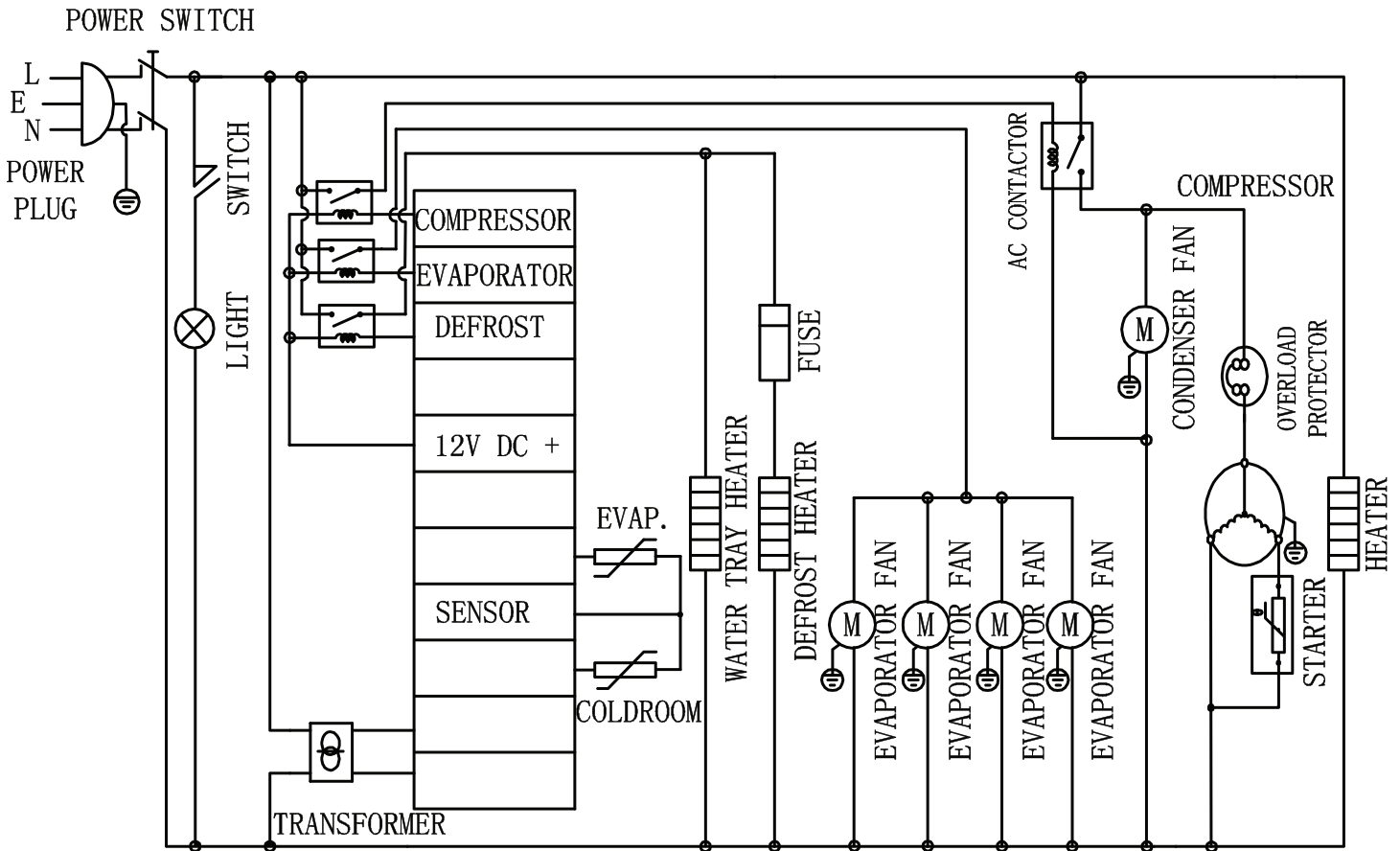

NEMA
 5 - 20P
 125VAC / 20 AMP



Warranty Registration

Thank you for purchasing an Omcan product. To register your warranty for this product, complete the information below, tear off the card at the perforation and then send to the address specified below. You can also register online by visiting:

Merci d'avoir acheté un produit Omcan. Pour enregistrer votre garantie pour ce produit, complétez les informations ci-dessous, détachez la carte au niveau de la perforation, puis l'envoyer à l'adresse spécifiée ci-dessous. Vous pouvez également vous inscrire en ligne en visitant:

Gracias por comprar un producto Omcan usted. Para registrar su garantía para este producto, complete la información a continuación, cortar la tarjeta en la perforación y luego enviarlo a la dirección indicada a continuación. También puede registrarse en línea en:

<https://omcan.com/warranty-registration/>

For mailing in Canada

Pour postale au Canada

Por correo en Canadá

OMCAN

PRODUCT WARRANTY REGISTRATION

3115 Pepper Mill Court,
Mississauga, Ontario
Canada, L5L 4X5

For mailing in the US

Pour diffusion aux États-Unis

Por correo en los EE.UU.

OMCAN

PRODUCT WARRANTY REGISTRATION

4450 Witmer Industrial Estates, Unit 4,
Niagara Falls, New York
USA, 14305

or email to: service@omcan.com



Purchaser's Information

Name: _____

Address: _____

City: _____ Province or State: _____ Postal or Zip: _____

Country: _____

Dealer from which Purchased: _____

Dealer City: _____ Dealer Province or State: _____

Invoice: _____

Model Name: _____ Model Number: _____

Machine Description: _____

Date of Purchase (MM/DD/YYYY): _____

Would you like to extend the warranty? Yes No

Company Name: _____

Telephone: _____

Email Address: _____

Type of Company:

Restaurant Bakery Deli

Butcher Supermarket Caterer

Institution (specify): _____

Other (specify): _____

Serial Number: _____

Date of Installation (MM/DD/YYYY): _____

Thank you for choosing Omcan | Merci d'avoir choisi Omcan | Gracias por elegir Omcan



Since 1951 Omcan has grown to become a leading distributor of equipment and supplies to the North American food service industry. Our success over these many years can be attributed to our commitment to strengthen and develop new and existing relationships with our valued customers and manufacturers. Today with partners in North America, Europe, Asia and South America, we continually work to improve and grow the company. We strive to offer customers exceptional value through our qualified local sales and service representatives who provide convenient access to over 6,500 globally sourced products.

Depuis 1951 Omcan a grandi pour devenir un des "leaders" de la distribution des équipements et matériel pour l'industrie des services alimentaires en Amérique du Nord. Notre succès au cours de ces nombreuses années peut être attribué à notre engagement à renforcer et à développer de nouvelles et existantes relations avec nos clients et les fabricants de valeur. Aujourd'hui avec des partenaires en Amérique du Nord, Europe, Asie et Amérique du Sud, nous travaillons continuellement à améliorer et développer l'entreprise. Nous nous efforçons d'offrir à nos clients une valeur exceptionnelle grâce à nos ventes locales qualifiées et des représentants de service qui offrent un accès facile à plus de 6500 produits provenant du monde entier.

Desde 1951 Omcan ha crecido hasta convertirse en un líder en la distribución de equipos y suministros de alimentos en América del Norte industria de servicios. Nuestro éxito en estos años se puede atribuir a nuestro compromiso de fortalecer y desarrollar nuevas relaciones existentes con nuestros valiosos clientes y fabricantes. Hoy con socios de América del Norte, Europa, Asia y América del Sur, que trabajan continuamente para mejorar y crecer la empresa. Nos esforzamos por ofrecer a nuestros clientes valor excepcional a través de nuestro local de ventas y representantes de los servicios que proporcionan un fácil acceso a más de 6,500 productos con origen a nivel mundial.

